



Model Systems  
Knowledge Translation  
Center

Resources Offered by the MSKTC  
To Support Individuals Living With  
**Spinal Cord Injury**



Edition 4  
July 2017

[www.MSKTC.org/SCI](http://www.MSKTC.org/SCI)



Spinal Cord Injury Model System



## Resources Offered by the MSKTC To Support Individuals Living With Spinal Cord Injury

---

**Edition 4  
May 2017**

This document may be reproduced and distributed freely.

The contents of this document were developed under a grant from the National Institute on Disability, Independent Living, and Rehabilitation Research (NIDILRR grant number 90DP0082). NIDILRR is a Center within the Administration for Community Living (ACL), U.S. Department of Health and Human Services (HHS). The contents of this document do not necessarily represent the policy of NIDILRR, ACL, HHS, and you should not assume endorsement by the Federal Government.

### **Model Systems Knowledge Translation Center**

American Institutes for Research  
1000 Thomas Jefferson Street, NW  
Washington, DC 20007

[www.MSKTC.org](http://www.MSKTC.org)

MSKTC@air.org

Phone: 202-403-5600

TTY: 877-334-3499

### **Connect with us on**



**Facebook: Spinal Cord Injury Model Systems**



**Twitter: SCI\_MS**

## About the Model Systems Knowledge Translation Center

The Model Systems Knowledge Translation Center (MSKTC) summarizes research, identifies health information needs, and develops information resources to support the Model Systems programs in meeting the needs of individuals with spinal cord injury (SCI), traumatic brain injury (TBI), and burn injury (Burn). The health information offered through the MSKTC is not meant to replace the advice from a medical professional. Users should consult their health care provider regarding specific medical concerns or treatment.

The current MSKTC cycle is operated by American Institutes for Research® (AIR®) in collaboration with the Center for Chronic Illness and Disability at George Mason University, BrainLine, University of Alabama, Inova, and American Association of People with Disabilities. The Center is funded by the U.S. Department of Health and Human Services (HHS), National Institute on Disability, Independent Living, and Rehabilitation Research (NIDILRR) under grant number 90DP0082.

<https://www.msktc.org/>

## About the Model Systems Program

Model Systems are specialized programs of care in spinal cord injury (SCI), traumatic brain injury (TBI), and burn injury (Burn). Model Systems conduct innovative and high-quality research, provide patient care, and offer other services to improve the health and overall quality of life for individuals with SCI, TBI, and burn injury. Model Systems are funded by the U.S. Department of Health and Human Services (HHS), National Institute on Disability, Independent Living, and Rehabilitation Research (NIDILRR).

### Spinal Cord Injury Model Systems

#### 2016–2021 Funding Cycle

##### Alabama

###### University of Alabama at Birmingham Spinal Cord Injury Model System

Spain Rehabilitation Center, Birmingham, AL

##### California

###### Southern California Spinal Cord Injury Model System

Rancho Los Amigos National Rehabilitation Center, Downey, CA

##### Colorado

###### The Rocky Mountain Regional Spinal Injury System

Craig Hospital, Englewood, CO

##### Florida

###### South Florida Spinal Cord Injury Model System

University of Miami, Miami, FL

##### Georgia

###### Southeastern Regional Spinal Cord Injury Care System

Shepherd Center, Inc., Atlanta, GA

##### Illinois

###### Midwest Regional Spinal Cord Injury Care System (MRSCIS)

Rehabilitation Institute of Chicago, Chicago, IL

##### Massachusetts

###### Spaulding New England Regional Spinal Cord Injury Center

Gaylord Hospital/New England Regional SCI, Boston, MA

##### New Jersey

###### Northern New Jersey Spinal Cord Injury System

Kessler Foundation Research Center, West Orange, NJ

##### New York

###### Mount Sinai Hospital Spinal Cord Injury Model System

Mount Sinai Hospital, New York, NY

##### Ohio

###### Ohio Regional Spinal Cord Injury Model System

Ohio State University Wexner Medical Center, Columbus, Ohio

###### Northeast Ohio Regional Spinal Cord Injury System

Case Western Reserve University, Cleveland, OH

##### Pennsylvania

###### Regional Spinal Cord Injury Center of the Delaware Valley

Thomas Jefferson University, Philadelphia, PA

###### University of Pittsburgh Model Center on Spinal Cord Injury

UMPC Rehabilitation Institute, Pittsburgh, PA

##### Texas

###### Texas Model Spinal Cord Injury System at TIRR

Memorial Hermann, Houston, TX

## About the National Spinal Cord Injury Statistical Center

The National Spinal Cord Injury Statistical Center (NSCISC) supports and directs the collection, management and analysis of the world's largest and longest spinal cord injury research database. Organizationally, NSCISC is currently the hub of the network of 14 NIDILRR-sponsored Spinal Cord Injury Model Systems and 5 subcontracts at formerly funded Model Systems located at major medical centers throughout the United States.

In addition to maintaining the national SCI database, NSCISC personnel conduct ongoing, database-oriented research. Many of the findings resulting from these investigative efforts have had significant impact on the delivery and nature of medical rehabilitation services provided to SCI patients.

The NSCISC for the 2016–2021 cycle is operated by the UAB Department of Physical Medicine and Rehabilitation and is funded by the U.S. Department of Health and Human Services (HHS), National Institute on Disability, Independent Living, and Rehabilitation Research (NIDILRR).

<https://www.nscisc.uab.edu/>

## Contents

Overview of Spinal Cord Injury Products Offered Through the MSKTC.....	4
Listing of Spinal Cord Injury Products Offered Through the MSKTC.....	5
Opportunities To Participate in MSKTC Research.....	6
Collection of Spinal Cord Injury Factsheets Offered by the MSKTC, Volume I.....	7
Depression and Spinal Cord Injury.....	9
Employment After Spinal Cord Injury.....	12
Pain After Spinal Cord Injury.....	16
Pain After Spinal Cord Injury Supplement: Activity Modification for Musculoskeletal Pain.....	20
Safe Transfer Technique.....	22
Skin Care and Pressure Sores (6 Part Series)—Part 1: Causes and Risks.....	24
Skin Care and Pressure Sores (6 Part Series)—Part 2: Preventing Pressure Sores.....	26
Skin Care and Pressure Sores (6 Part Series)—Part 2: Preventing Pressure Sores Supplement: Areas at high risk of developing pressure sores.....	30
Skin Care and Pressure Sores (6 Part Series)—Part 2: Preventing Pressure Sores Supplement: Building Skin Tolerance for Pressure.....	31
Skin Care and Pressure Sores (6 Part Series)—Part 2: Preventing Pressure Sores Supplement: How to do pressure reliefs (weight shifts).....	32
Skin Care and Pressure Sores (6 Part Series)—Part 3: Recognizing and Treating Pressure Sores.....	35
Skin Care and Pressure Sores (6 Part Series)—Part 3: Recognizing and Treating Pressure Sores Supplement: stages of pressure sores: Illustrations.....	37
Spasticity and Spinal Cord Injury.....	39
Spinal Cord Injury and Gait Training.....	42
The Wheelchair Series: What the Spinal Cord Injury Consumer Needs to Know (3 Part Series) Getting the Right Wheelchair: What the Spinal Cord Injury Consumer Needs to Know.....	46
The Manual Wheelchair: What the Spinal Cord Injury Consumer Needs to Know.....	49
The Power Wheelchair: What the Spinal Cord Injury Consumer Needs to Know.....	52
Collection of Spinal Cord Injury Factsheets Offered by the MSKTC, Volume 2.....	55
Adaptive Sports and Recreation.....	56
Adjusting to Life After Spinal Cord Injury.....	62
Autonomic Dysreflexia.....	66
Bladder Management Options Following Spinal Cord Injury.....	70
Bowel Function After Spinal Cord Injury.....	77
Driving After Spinal Cord Injury.....	81
Exercise After Spinal Cord Injury.....	85
Pregnancy and Women with Spinal Cord Injury.....	92
Respiratory Health and Spinal Cord Injury.....	96
Sexuality & Sexual Functioning After Spinal Cord Injury.....	100
Surgical Alternatives for Bladder Management Following Spinal Cord Injury.....	104
Understanding Spinal Cord Injury—Part 1: The Body Before and After Injury.....	108
Understanding Spinal Cord Injury—Part 2: Recovery and Rehabilitation.....	111
Urinary Tract Infection and Spinal Cord Injury.....	117

## Overview of MSKTC Spinal Cord Injury Products Offered Through the MSKTC

The Model Systems Knowledge Translation Center (MSKTC) offers a variety of free resources on spinal cord injury (SCI) to support people with disabilities and their caregivers, researchers, practitioners and clinicians, and policy makers. The following resources are available at [www.MSKTC.org/SCI](http://www.MSKTC.org/SCI).

### SCI Factsheets

The MSKTC collaborates with SCI Model Systems to produce evidence-based and consumer-friendly factsheets.

### SCI Slideshows

The MSKTC develops traditional and narrated slideshows based on information from select factsheets. These resources are developed for users who prefer a format with more images, less text, or an audio option.

### SCI Hot Topic Modules

The MSKTC develops Hot Topic Modules, which are a collection of resources such as videos, factsheets, and slideshows to support individuals who live with SCI.

### SCI Quick Research Reviews

The MSKTC provides quick review of Model Systems research studies funded by the National Institute on Disability, Independent Living, and Rehabilitation Research (NIDILRR). Those reviews offer timely summaries of newly released model system research studies using lay language for easy access.

### SCI Systematic Reviews

The MSKTC collaborates with Model System programs to conduct systematic reviews on high-priority health topics to inform clinical practice. Results of a systematic review provide the best information for making decisions about treatment, practice or behavior.

### SCI Research Database

The MSKTC maintains a database of more than 800 SCI citations and abstracts of studies funded by NIDILRR.

## Listing of Spinal Cord Injury Products Offered Through the MSKTC

### SCI Products Available on MSKTC.org/SCI as of May 2017

#### SCI Factsheets

- Adaptive Sports and Recreation
- Adjusting to Life After SCI
- Autonomic Dysreflexia
- Bladder Management Options Following SCI
- Bowel Function After SCI
- Depression and SCI
- Driving After SCI
- Employment After SCI
- Exercise After SCI
- Pain After SCI
- Pregnancy and Women with SCI
- Respiratory Health and SCI
- Safe Transfer Technique
- Sexuality & Sexual Functioning After SCI
- Skin Care and Pressure Sores (6 Part Series)
- Spasticity and SCI
- SCI and Gait Training
- The Wheelchair Series: What the SCI Consumer Needs to Know (3 Part Series)
- Surgical Alternatives for Bladder Management Following SCI
- Understanding SCI—Part 1: The Body Before and After Injury
- Understanding SCI—Part 2: Recovery and Rehabilitation
- Urinary Tract Infection and SCI

#### SCI Research Database

More than 800 studies conducted by SCI Model Systems researchers

#### SCI Slideshows

- Bowel Function After SCI
- Employment After SCI
- Pain After SCI
- Pregnancy and Women with SCI
- Safe Transfer Techniques
- Gait Training After SCI

#### SCI Hot Topic Modules

- Managing Bowel Function After SCI
- Managing Pain After SCI

#### SCI Systematic Reviews

- Prevention and Treatment of Bone Loss in SCI
- SCI and Adverse Exercise Effects
- SCI and Measures of Major Depression
- SCI and Sleep Apnea

#### SCI Quick Research Reviews

SCI Quick Research Reviews of Model Systems publications are frequently posted on the MSKTC Web Site

### Coming Soon to MSKTC.org/SCI

#### SCI Factsheets

- SCI and Health Maintenance
- SCI and Tendon Transfer

#### SCI Slideshows

- Adjusting to Life After SCI
- Driving After SCI
- Sexuality and Sexual Functioning After SCI

#### SCI Systematic Reviews

- SCI and Family Impact
- SCI and Transition
- Women With SCI

## Opportunities To Participate in MSKTC Activities

Involvement from the field plays a critical role in the success of the MSKTC. Periodically, we recruit individuals with spinal cord injury and their family members, caregivers, and clinicians to participate in MSKTC activities. We sometimes offer a small financial token of appreciation to participants. Examples of activities include:

- ◆ Providing feedback on factsheets
- ◆ Offering input on videos
- ◆ Participating in a conversation about the needs of those with spinal cord injury and their supporters

If you are interested in learning more about these activities or participating, please email [MSKTC@air.org](mailto:MSKTC@air.org) or call 202-403-5600.

## Collection of SCI Factsheets Offered by the MSKTC

This section contains SCI factsheets offered by the MSKTC as of May 2017. These and other resources are available at no charge on [MSKTC.org/SCI](http://MSKTC.org/SCI).

### Volume 1: Factsheets developed 2007–2012

- ◆ Depression and Spinal Cord Injury
- ◆ Employment After Spinal Cord Injury
- ◆ Pain After Spinal Cord Injury
- ◆ Safe Transfer Technique
- ◆ Skin Care and Pressure Sores (6 Part Series)
- ◆ Spasticity and Spinal Cord Injury
- ◆ Spinal Cord Injury and Gait Training
- ◆ The Wheelchair Series: What the SCI Consumer Needs to Know (3 Part Series)

### Volume 2: Factsheets developed 2012–2017

- ◆ Adaptive Sports and Recreation
- ◆ Adjusting to Life After Spinal Cord Injury
- ◆ Autonomic Dysreflexia
- ◆ Bladder Management Options Following Spinal Cord Injury
- ◆ Bowel Function After SCI
- ◆ Exercise After Spinal Cord Injury
- ◆ Driving After Spinal Cord Injury
- ◆ Pregnancy and Women with Spinal Cord Injury
- ◆ Respiratory Health and Spinal Cord Injury
- ◆ Sexuality & Sexual Functioning After Spinal Cord Injury
- ◆ Surgical Alternatives for Bladder Management Following Spinal Cord Injury
- ◆ Understanding Spinal Cord Injury: Part 1—The Body Before and After Injury
- ◆ Understanding Spinal Cord Injury: Part 2—Recovery and Rehabilitation
- ◆ Urinary Tract Infection and Spinal Cord Injury



# **Volume 1: Factsheets Developed 2007–2012**

---



# Depression and Spinal Cord Injury



For more information, contact your nearest SCI Model System. For a list of SCI Model Systems go to:

<http://www.msktc.org/sci/model-system-centers>

This publication was produced by the SCI Model Systems in collaboration with the University of Washington Model Systems Knowledge Translation Center with funding from the National Institute on Disability and Rehabilitation Research in the U.S. Department of Education, grant no. H133A060070.

Depression is common and can affect anyone. About 1 in 20 Americans (over 11 million people) get depressed every year. Depression is even more common in the spinal cord injury (SCI) population—about one in five people. Estimated rates of depression among people with SCI range from 11% to 37%.

## What is depression?

Depression is not just “feeling blue” or “down in the dumps.” It is a serious medical disorder (just like diabetes, in which both biology and behavior can help or hurt). Depression is closely linked to your thoughts, feelings, physical health and daily activities. Depression affects both men and women. Depression can cause some or all of the following physical and psychological symptoms:

- Changes in sleep (too much or too little)
- Feeling down or hopeless
- Loss of interest or pleasure in activities
- Changes in appetite
- Diminished energy or activity
- Difficulty concentrating or making decisions
- Feelings of worthlessness or self-blame
- Thoughts of death or suicide

Periods of sadness are normal after SCI. However, there is cause for concern when feeling depressed or losing interest in usual activities occurs almost daily and lasts for more than two weeks. Depression is not caused by personal weakness, laziness or lack of will power.

## Causes of depression

Although we don't know for sure what causes depression, we do know that life stresses and medical problems can cause a change in certain brain chemicals, called neurotransmitters. This chemical imbalance is linked to changes in mood, enjoyment, sleep, energy, appetite and ability to concentrate.

## Depression can and should be treated

The good news is that the symptoms of depression can almost always be treated with specific types of counseling or antidepressant medications. However, a combination of both counseling and antidepressant medication has been shown to have the best results. Regular exercise or physical activity can also

improve mood, especially when used together with counseling or medications.

It is important to treat depression because it can have such a harmful effect on a person’s ability to function in day-to-day life. Depression can make pain worse, make sleep difficult, sap your energy, take away your enjoyment and make it difficult for you to take good care of your health.

Untreated depression can last 6 to 12 months or more. Thoughts of death is a symptom of depression. The risk of suicide is higher while someone is depressed. Due to both brain chemistry and thought patterns, often people who have severe depression and suicidal thoughts have difficulty seeing a way out of their problems. Suicidal thinking goes away once depression is treated.

### What counseling really is

Counseling or psychotherapy is often misunderstood. There are many different kinds of therapy, but one type that has been proven to help depression is called “cognitive-behavioral therapy.” Cognitive-behavioral therapy is based on the idea that depression improves when people are more engaged in meaningful activities and when they regain their positive beliefs and attitudes about themselves, their world and their future. The therapist helps you find or resume activities that are meaningful or enjoyable to you. There will be barriers to overcome, so the therapist supports you like a coach to help resolve the problems you face. The therapist also helps you recognize how your thinking becomes more negative in depression and how, through experimentation and logic, you can improve your outlook and rebuild confidence.

### How do antidepressants work?

Antidepressant medications seem to work by restoring a normal balance of important brain chemicals such as norepinephrine and serotonin. Rebalancing these chemicals leads to feeling better both emotionally and physically. Treating depression can also help you function better at home and at work. Antidepressants are not addictive. Some people get side effects, but they tend to lessen over time.

### Depression Self-Test

For each of the nine items listed below, circle the number (0-3) that corresponds to how often you have been bothered by that problem over the past two weeks.

<b>Over the last 2 weeks, how often have you been bothered by any of the following problems?</b>	Not at all	Several days	More than half the days	Nearly every day
1. Little interest or no pleasure in doing things.	0	1	2	3
2. Feeling down, depressed, or hopeless.	0	1	2	3
3. Trouble falling or staying asleep, or sleeping too much.	0	1	2	3
4. Feeling tired or having little energy.	0	1	2	3
5. Poor appetite or over-eating.	0	1	2	3
6. Feeling bad about yourself or that you are a failure or have let yourself or your family down.	0	1	2	3
7. Trouble concentrating on things, such as reading the newspaper or watching television.	0	1	2	3
8. Moving or speaking so slowly that other people could have noticed. Or the opposite: being so fidgety or restless that you have been moving around a lot more than usual.	0	1	2	3
9. Thoughts that you would be better off dead or of hurting yourself in some way.	0	1	2	3

Copyright © 2005 Pfizer, Inc. All rights reserved. Reproduced with permission.

### What you can do

1. Take a “depression self-test” like the one above.
2. Answer all the questions honestly, add up your score and see where your score falls.
3. If your score is 10 or higher and you have been feeling this way for more than a week or two, contact your health care provider or

a psychologist, psychiatrist or counselor who has experience treating depression.

4. If you are having thoughts of death or suicide, contact your health care provider or a mental health specialist immediately. Also, inform those around you about how badly you are feeling so that they can support you and help keep you safe while you go through this difficult period.

**If you are in danger of harming yourself now, please call 911, the 24-hour National Crisis Hotline at 800-273-8255, or your local Crisis Clinic right away.**

Remember, depression is not a necessary or inevitable part of living with SCI. In fact, most people with SCI are not depressed. If you are struggling with depression or feeling low for more than two weeks, talk to your doctor. Depression is treatable and beatable.

## How to find help

Many mental health professionals are qualified to treat depression. For example, psychiatrists have specialized training in medication management for depression and psychologists are trained to provide counseling for depression.

Other physicians, such as primary care physicians, neurologists and physiatrists, and nurse practitioners with experience in treating depression can often get treatment started and refer you to mental health professionals as needed.

When available, seek treatment from a comprehensive spinal cord injury rehabilitation program that can address all aspects of SCI recovery.

## Source

Our health information content is based on research evidence whenever available and represents the consensus of expert opinion of the SCI Model System directors.

## Authorship

*Depression and Spinal Cord Injury* was developed by Charles H. Bombardier, PhD, in collaboration with the University of Washington Model Systems Knowledge Translation Center.

This document was adapted from materials developed by the Northwest Regional SCI System.

## Disclaimer

This information is not meant to replace the advice from a medical professional. You should consult your health care provider regarding specific medical concerns or treatment.



# Employment after Spinal Cord Injury



For more information, contact your nearest SCI Model System. For a list of SCI Model Systems go to: <http://www.msktc.org/sci/model-system-centers>

This publication was produced by the SCI Model Systems in collaboration with the University of Washington Model Systems Knowledge Translation Center with funding from the National Institute on Disability and Rehabilitation Research in the U.S. Department of Education, grant no. H133A060070.

Most people with spinal cord injuries (SCI) want to work yet need support, training and vocational rehabilitation services to help them obtain and keep a job. These sources of support may help to overcome many barriers that are outside the individual's control, such as financial and health care issues, accessibility, and employer attitudes.

Work is important to people not only because they can earn an income and receive health insurance and other benefits, but also because it gives them opportunities to interact with others and improved self-esteem and overall life satisfaction. And although there is no cause-effect relationship, there are consistent findings in the research that people who are employed after SCI live longer and report higher satisfaction with life and better health than people who are not working.

Although individuals with SCI can and do go on to have active work lives and successful careers, they have more barriers to overcome than those without disabilities. Federal and state laws and vocational rehabilitation services exist to help people with disabilities overcome these barriers.

## The law protects you

Passed in 1990 and amended in 2008, the federal Americans with Disabilities Act (ADA) prohibits employers from discriminating against qualified individuals with disabilities who are able to perform the essential functions of the job with or without accommodation.

- To be protected under this law, you must have a disability that limits major life activities. Nearly all people with SCI are protected under ADA.
- An employer must make "reasonable accommodation" to your disability if it would not impose an undue hardship on the business. Whether an accommodation is considered a "hardship" depends on the business size, financial resources, nature of operation and other factors.
- When you apply for a job, an employer cannot ask you about the existence, nature or severity of your disability, even if you show up for your interview in a wheelchair. An employer can ask you about your ability to perform certain job functions.
- An employer can require you to pass a medical examination **only** if it is job-related and required of **all** employees in similar jobs.
- If you feel an employer has discriminated against you, contact the U.S. Equal Employment Opportunity Commission (EEOC). Call 800-669-4000 to find the office nearest you, or go to [www.eeoc.gov](http://www.eeoc.gov). Many states have powerful disability rights laws as well.

The Individuals with Disabilities Education Act (IDEA) is a law that helps young people who have not yet finished their K-12 education receive the services they need to meet their academic and vocational goals and to ensure a smooth transition into adult life. Students eligible under this law may remain in school until age 22 if the extra time is necessary to achieve their goals. For more information, contact the U.S. Department of Education (800-872-5327) or visit the IDEA 2004 website at <http://idea.ed.gov/>.

## What is vocational rehabilitation?

Vocational rehabilitation programs can help individuals with disabilities obtain employment. Through these programs, a wide range of services are available to help people identify their career interests and skills; acquire the relevant education or training; find and apply for jobs; and get work accommodations. For people who are covered under worker's compensation (because they were injured on the job), a similar set of vocational rehabilitation programs are often available.

## Who pays?

- **Some private health insurance companies** pay for vocational rehabilitation services. Check with your insurer to find out what services are covered.
- **State vocational rehabilitation programs** are funded (through federal mandate) to provide free vocational rehabilitation services for anyone with a significant disability that limits their ability to work. Services include all the steps in the vocational rehabilitation process described in this factsheet.
- **State workers' compensation programs** provide free vocational rehabilitation services for individuals who have been injured on the job.
- **The Veterans Administration (VA)** provides vocational rehabilitation services to eligible beneficiaries with service related disabilities.

## How does vocational rehabilitation work?

Vocational rehabilitation can take place at any time an individual with a disability needs help finding or keeping employment. If you are not

working but are interested in finding employment, or if you are dissatisfied with your current job, you might try vocational rehabilitation.

Whenever the process begins, it includes the following steps:

### Getting started

Your rehabilitation medicine physician can refer you to a vocational rehabilitation program, or you can find these services yourself by visiting <http://askjan.org/cgi-win/TypeQuery.exe?902> for a listing of the State Vocational Rehabilitation offices.

In many settings, vocational rehabilitation services are provided by rehabilitation counselors with master's degrees who are specially trained to help people with disabilities find and keep employment.

### Assessment

Finding satisfying employment means matching your interests and needs with the characteristics and demands of jobs. Being able to find and maintain employment will also depend on your abilities to meet the requirements of the jobs that are available in the job market or your current job.

Your rehabilitation counselor will begin by helping you to evaluate your interests, skills, limitations, health needs, work and education histories, and even personality style. The counselor gets this information through interviews, questionnaires, medical information from your physician, and sometimes tests of academic aptitude and skills. Your counselor may also set up real life opportunities for you to find out more about various jobs.

### Real-life "tests"

Your rehabilitation counselor may be able to set up a "trial" work situation for you with a potential employer for a specified period of time to see if you are able to do the job, if you like the job, and what accommodations you might need. These situations may be paid or unpaid. After the trial period, both you and the employer can decide whether it will be a good long-term fit.

### The job market

Part of the process may be assessing the job market related to various occupations. You may be interested in a specific job in a particular industry

but if that industry is declining or does not have opportunities in your geographic area, you might need to look into something different. Your rehabilitation counselor can help you assess the job opportunities in your area, as well as the wages, tasks, education preparation and other characteristics of occupations you might be interested in.

## Setting goals

The end-product of the rehabilitation counseling process is deciding on the specific career or occupation you want to pursue. This is your long-term goal. To get there, you may need to complete several intermediate steps along the way. These steps should be described in as much detail as possible in a written plan that you and your rehabilitation counselor create together.

For example, you may need to finish high school or attend college to enter the occupation of your choice, or perhaps you can go right to work. To do either, you may need to increase your physical endurance, find reliable accessible transportation and accessible housing, and manage your medical needs so you can meet the demands of a job schedule.

## Landing a job

After thorough preparation and planning, people with SCI often secure jobs on their own. Sometimes they need extra help, however. A rehabilitation counselor can help you determine whether a potential job would be a good match for you. He or she can conduct a job analysis to determine the actual kinds of tasks done in that particular job, the cognitive (thinking), social and physical demands of the job, and the need for accommodations. A job placement specialist can help you identify specific opportunities in your geographic area.

Discrimination in hiring is illegal even if it is not intentional. Employers with no experience interacting with people who have disabilities may assume someone with a disability cannot do the work or hold down a job. In these cases, a rehabilitation counselor can step in and work with the employer to overcome prejudices and suggest accommodations that improve the employer's comfort in hiring a person with a disability.

## Getting support at work

You may need ongoing support and accommodations at work. Someone with high-level tetraplegia, for example, may need help with positioning or personal care assistance during the work day. These are typically not paid for by the employer, and a source of funding for this assistance must be identified in advance.

## Types of accommodations

Job accommodations can include modifying work schedules, tasks or the work environment. Solutions can range from simple to high-tech.

Examples:

- Removing a desk drawer or raising the height of a desk with four wood blocks so a wheelchair can fit underneath.
- Special software and hardware so a person with no hand function can work on a computer.
- A private changing area for someone who may have occasional bladder accidents.
- Shifting work hours to a later start and end to the work day to accommodate a worker's lengthy morning care needs.
- If a person has both SCI and a brain injury, he or she may need additional support in the form of extra supervision or job "coaching."

A rehabilitation counselor can help determine what kinds of accommodations might be helpful and whether they constitute "undue hardship" for the employer.

## Work vs. benefits: finding a balance

Sometimes people are reluctant to start working because they don't want to lose their medical benefits under Social Security Disability Insurance (SSDI), Supplementary Security Income (SSI), or private or state long-term disability insurance (LTD). They may also be concerned about the extra costs of getting to or staying at work.

Federal work incentive programs under SSDI or SSI allow people with disabilities to receive benefits and federal health care (Medicare and/or Medicaid) while still keeping some of their earnings from employment. This can be a powerful



incentive for someone with a high-level SCI who has a strong desire to work but needs personal care assistance on the job, must pay for a van, and needs other services in order to work. Some LTD policies include vocational rehabilitation benefits or incentives to return to work.

Work-incentive programs are complicated, and you may want to consult your vocational rehabilitation counselor, a resource specialist with an independent living center, or a social worker familiar with benefits systems. (Also see “Resources,” below.)

## If employment is not possible

Sometimes it is not possible for a person to obtain any kind of work after SCI. This includes people who cannot earn enough by working to pay for their own personal care assistance and other disability costs. People who live in rural areas may not have access to transportation or employment. Older workers may not be able to transfer their pre-injury skills to a new occupation. In these cases, the individual can apply for disability benefits with the help of the rehabilitation counselor or other health provider.

A person is eligible to receive disability payments from the Social Security Administration (SSA) if he or she is unable to perform any kind of work at a level of “substantial and gainful” activity and the disability is expected to last at least a year.

The SSA pays disability benefits under two programs:

- **Social Security Disability Insurance (SSDI)** is a long-term disability insurance program funded by payroll taxes. Eligibility is based on your past work history and income.
- **Supplemental Security Income (SSI)** is a federal welfare program for people with disabilities who are unable to work and are low income.

**Newly injured individuals with SCI should apply for SSA benefits immediately if it seems likely that they will not return to work for at least a year.** Sometimes there is a waiting period before starting to receive benefits. Once enrolled, a person is immediately eligible for either state Medicaid benefits or, after a waiting period, for federal Medicare benefits.

## The case for volunteering

If paid employment is not possible, consider getting involved in a volunteer activity. Not only can volunteering provide enjoyment and a sense of accomplishment, it can give you the skills, confidence and professional contacts that might eventually lead to paid employment some day.

## Reference

Johnson, K. (2009). Vocational Rehabilitation (pp. 715–722). In V. Lin (Ed.), *Spinal cord medicine: Principles and Practice*. New York: Demos.

## Resources

- Benefits for People with Disabilities, Social Security Administration: <http://www.ssa.gov/disability/>
- Find your local Vocational Rehabilitation Agency, Job Accommodation Network, U.S. Department of Labor: <http://askjan.org/cgi-win/TypeQuery.exe?902>
- The Red Book: A Guide to Work Incentives, Social Security Administration: <http://www.socialsecurity.gov/redbook/>
- Social Security Area Work Incentive Coordinators (AWIC) provide information about work incentive programs. You can find the AWIC in your area at <http://www.ssa.gov/work//awiccontacts.html>.

## Source

Our health information content is based on research evidence whenever available and represents the consensus of expert opinion of the SCI Model System directors and staff.

## Authorship

*Employment after Spinal Cord Injury* was developed by Kurt Johnson, PhD and Jim Krause, PhD, in collaboration with the University of Washington Model Systems Knowledge Translation Center.

## Disclaimer

This information is not meant to replace the advice from a medical professional. You should consult your health care provider regarding specific medical concerns or treatment.

# Pain after Spinal Cord Injury



For more information, contact your nearest SCI Model System. For a list of SCI Model Systems go to: <http://www.msctc.org/sci/model-system-centers>

This publication was produced by the SCI Model Systems in collaboration with the University of Washington Model Systems Knowledge Translation Center with funding from the National Institute on Disability and Rehabilitation Research in the U.S. Department of Education, grant no. H133A060070.

## The problem of pain after SCI

Pain is a serious problem for many people with spinal cord injuries (SCI). Pain after SCI can occur in parts of the body where there is normal sensation (feeling) as well as areas that have little or no feeling. The pain is very real and can have a negative impact on quality of life. A person in severe pain may have difficulty carrying out daily activities or participating in enjoyable pastimes.

The majority of people with SCI report that they have chronic pain. Chronic pain is pain that does not go away and instead lasts months to years. The cause of the pain may be unknown but is most often related to nerve damage from the SCI or musculoskeletal problems that arise in dealing with an SCI. The pain can come and go. Chronic pain is difficult to completely eliminate but often can be managed or reduced enough so that it doesn't overwhelm your life.

Chronic pain can cause or worsen psychological problems such as depression, anxiety and stress. This does not mean the pain is "all in your head," but rather that pain and distress can make each other worse.

Even though pain after SCI can be complicated and difficult to treat, there are many treatments available that can help. Understanding your pain, working with your doctor and being open to a variety of treatments will help you manage your pain and improve your quality of life. Many people with difficult chronic pain problems after SCI have found relief using techniques described here.

## Types of pain

A person with SCI can have many different types of pain in different locations, including areas where there is not usually any feeling. Understanding what type of pain you have is key to choosing the right treatment. Therefore, your doctor will ask you to describe your pain in a variety of ways, including its locations, severity, how long you have had it, what makes it worse or better and so on. Your doctor also may ask you to undergo tests such as an x-ray or MRI (magnetic resonance imaging).

## Neuropathic pain

Neuropathic pain ("neurogenic pain") is caused by abnormal communication between the nerves that were damaged by your spinal cord injury and the brain, where nerve signals that inform your brain how your body feels are interpreted. In neuropathic pain, it is thought that the brain "misunderstands" or amplifies the intensity of the signals it is getting from around the area of your injury. This can cause you to experience pain coming from areas of your body below where you have little or no feeling. This is why a person can feel neuropathic pain in an area that otherwise has no feeling.

People often use words such as *burning*, *stabbing* or *tingling* to describe neuropathic pain, but neuropathic pain varies a great deal from person to person. It is often very difficult to treat, and frequently a combination of treatments must be used.

- **Note:** If pain starts years after injury, it may be due to a new medical problem, such as a syrinx, a fluid-filled cavity that forms in the spinal cord. It is rare but may require surgery. Therefore, it is very important to contact a doctor if you notice any new loss of sensation, especially in areas around the level of your injury, and any muscle weakness that doesn't improve with rest.

### Musculoskeletal pain

Musculoskeletal pain is caused by problems in the muscles, joints or bones. It is a common problem for all people as they get older, including those with SCI.

Musculoskeletal pain can be caused by injury, overuse or strain, arthritic changes, or wear and tear of the joints, often from wheelchair use (including inadequate support for sitting) and/or transfers. It usually gets worse with movement and better with rest.

- **Upper limb (shoulder, elbow and hand) pain** is often caused by overuse of the muscles from doing transfers and pressure relief maneuvers and from pushing a wheelchair. It can occur months or many years after injury. People with higher level injuries who use computers or joysticks for many activities (reading, communicating, environmental controls) may develop pain in the hand, arm or shoulder from overuse. Upper limb pain can make it difficult for you to transfer safely and perform other activities of daily living.
- **Back and neck pain** are common problems. In people with paraplegia who have had surgery to fuse their spine, increased motion that occurs just above and just below the fusion can lead to back pain. People with tetraplegia (quadriplegia) may also have back pain, especially if they are able to walk but still have weakness. People who use chin- or mouth-operated joysticks may sometimes develop neck pain.
- **Muscle spasm pain** happens when muscles and joints are strained from spasticity.

### Visceral pain

Visceral pain is located in the abdomen (stomach and digestive area) and is often described as cramping and/or dull and aching. It can be caused by a medical problem such as constipation, a kidney stone, ulcer, gall stone or appendicitis. Since a person with SCI may not have the usual symptoms associated with these medical conditions, it is important to see a doctor who has had experience caring for SCI patients in order to get a correct diagnosis and treatment.

Pain that comes from a visceral problem is sometimes felt in an area away from the source of the problem. This is called *referred* pain. One common example is shoulder pain that results from gallbladder disease.

### Managing pain after SCI

Since pain can have so many different causes there is no single way to treat it. You and your doctor may need to try a combination of drugs, therapy and other treatments, including psychological treatments, and this may take some time to work out.

#### Physical treatments and interventions

- **Activity modification for musculoskeletal pain.** Changes in your mobility equipment (wheelchair, sliding board), your wheelchair pushing and transfer techniques, and in the way you do pressure reliefs can significantly decrease pain in your muscles and joints. Exercises that strengthen and balance your joints can also help reduce musculoskeletal pain. For information, please see the supplement “**Activity Modification for Musculoskeletal Pain.**”
- **Physical therapy** is used to treat musculoskeletal pain. Stretching and range of motion exercises may help relieve pain associated with muscle tension. Exercises that strengthen weak muscles can restore balance in painful joints and reduce pain.
- **Therapeutic massage** may help relieve musculoskeletal pain due to muscle tightness and muscle imbalance.
- **Acupuncture** is used to treat musculoskeletal pain. Tiny needles are inserted into the skin at specific points on the body. This method is

thought to work by stimulating the body's pain control system or by blocking the flow of pain.

- **Transcutaneous electrical nerve stimulation (TENS)** is sometimes used to treat musculoskeletal pain. Electrodes are placed on the surface of your skin and send low levels of electrical current into your body. The current blocks signals from the areas of nerve damage that are triggering a pain response.

### Psychological treatments for pain

We now know that people can learn to use psychological techniques to help them manage their pain better so it doesn't take over their lives. Psychologists trained in pain management can help with a variety of techniques proven to be effective in reducing the intensity and impact of pain.

- **Relaxation techniques and/or biofeedback** designed to teach you how to reduce muscle pain tension and "mental tension" associated with pain can be helpful in self-management.
- **Self-hypnosis training** has proven helpful for reducing chronic pain in some individuals.
- **Cognitive restructuring.** Learning how to think differently about your pain and its effects can actually lead to changes in brain activity and, in turn, the experience of pain.
- **Individual psychotherapy** designed to help identify desired goals and increase pleasure and meaning in daily life can help reduce pain. Therapy can also help if there is a significant amount of anxiety associated with pain.

### Medications

There are many different medications to treat pain. All of the medications listed below have shown some success in reducing pain, but none do so completely in every instance. All have possible side effects, some of which can be serious. Discuss all side effects with your doctor. Sometimes combinations of drugs work better than a single drug.

- **Non-steroidal anti-inflammatory drugs** (also known as NSAIDs) such as aspirin, ibuprofen (Motrin, Advil) and naproxen are most commonly used to treat musculoskeletal pain. Side effects may include stomach upset or bleeding problems.

- **Antiseizure medications** such as gabapentin (Neurontin) and Pregabalin (Lyrica) are used to treat neuropathic pain. Side effects include dizziness, sleepiness and swelling.
- **Antidepressants** are used to treat neuropathic pain and depression. These medications include selective serotonin norepinephrine reuptake inhibitors (SSNRIs), such as venlafaxine (Effexor), and tricyclics, such as amitriptyline (Elavil). Side effects include dry mouth, sleepiness, dizziness and (with SSNRIs) nausea.
- **Narcotics (opiates)** such as morphine, codeine, hydrocodone and oxycodone are used to treat neuropathic and musculoskeletal pain. These drugs have many side effects, including constipation and sleepiness, and can be habit forming. You may also develop dependency on these drugs and may have withdrawal symptoms if you suddenly stop taking them. However, they can be used effectively for many people, and while not the first consideration for chronic pain management, should not be dismissed because of fears about dependency or side effects.
- **Muscle relaxants and anti-spasticity** medications such as diazepam (Valium), baclofen (Lioresal) and tizanidine (Zanaflex) are used to treat spasm-related and musculoskeletal pain. These may be taken by mouth or delivered directly to the spinal cord through an implanted pump (see "Intrathecal pumps" below). These drugs can cause sleepiness, confusion and other side effects.
- **Topical local anesthetics** such as lidocaine (Lidoderm) are used to treat pain that occurs when skin is lightly touched (called *allodynia*).

### Surgical Treatments

- **Dorsal column stimulator** is used to treat neuropathic pain due to nerve root damage. A high frequency, low intensity nerve stimulator is surgically placed in the spinal canal next to the spinal cord or nerve roots.
- **Intrathecal pumps** are used to treat neuropathic pain (using morphine) or muscle spasm-related pain (using baclofen) A pump containing morphine or baclofen is surgically placed under

the skin in the abdomen. It delivers the medication directly to the spinal cord and nerve roots.

## Prevention and self-care

- **Get treatment for medical problems.** Overall health can have a big impact on pain. Urinary tract infections, bowel problems, skin problems, sleep problems and spasticity can make pain worse or harder to treat. Keeping yourself as healthy as possible can help reduce pain.
- **Try to get as much exercise as possible.** Getting regular physical activity can reduce pain as well as improve mood and overall health. It can also be enjoyable and distract you from pain. Your health provider can help you choose physical activities that are safe and appropriate for you. Also see the supplement “**Activity Modification for Musculoskeletal Pain.**”
- **Get treatment for depression.** Depression can make pain worse. It is best treated through counseling and medication. Getting treatment for depression can help you cope with chronic pain and improve your quality of life.
- **Reduce stress.** Stress can make pain worse or make the pain harder to cope with. You can learn to manage stress through counseling and learning techniques to help you reduce stress and tension, such as relaxation training, biofeedback and hypnosis. Exercise helps reduce stress.
- **Distract yourself.** Distraction is one of the best methods for coping with chronic pain. Participating in enjoyable and meaningful activities can help reduce pain and help you feel more in control of your life, especially when pain is at its worst. When you are bored and inactive, you tend to focus more on your pain, and this can make your pain feel worse.
- **Keep a record.** Everyone’s pain is a little different. Keep a record of what makes you feel better and what makes pain worse. Understanding things that affect your pain will help you and your doctor to find effective ways to reduce your pain.
- **Get a wheelchair seating evaluation.** Poor posture and improper seating can cause serious pain problems. Get your seating evaluated by a physical therapist who specializes in wheelchair seating. If you use a manual wheelchair, try to get

a high-strength, fully customizable chair made of the lightest material possible (aluminum or titanium). Learn the proper wheelchair propulsion (pushing) technique from a physical therapist. (See the supplement “**Activity Modification for Musculoskeletal Pain.**”)

- **Do not use alcohol to ease pain.** Using alcohol as a pain medication can lead to alcohol abuse and other serious problems. Some medications should not be mixed with alcohol. Ask your doctor about drinking alcohol, and always read the labels of your prescriptions.

## Finding help

If you have pain, it is important to get treatment for it. The ideal source of help would be a physician and psychologist familiar with SCI and pain management, working together.

If you do not have easy access to such experts, the next best alternative is to seek help from a multidisciplinary pain clinic where physicians and psychologists are available. Work closely with a health care provider with whom you are comfortable and who understands your condition.

Chronic pain is not hopeless. Try not to become discouraged if one treatment doesn’t work, and be open to trying a variety of different techniques. While complete relief from pain may not be possible, living better despite pain is a realistic goal.

## Resources

- Pain Connection, [www.painconnection.org](http://www.painconnection.org)
- American Pain Society, [www.ampainsoc.org](http://www.ampainsoc.org)
- American Pain Foundation, [www.painfoundation.org](http://www.painfoundation.org)
- CareCure Community Moderated Forums, including a pain forum. <http://sci.rutgers.edu/forum/>

## Source

Our health information content is based on research evidence and/or professional consensus and has been reviewed and approved by an editorial team of experts from the SCI Model Systems.

## Authorship

*Pain after Spinal Cord Injury* was developed by J. Scott Richards, PhD, Trevor Dyson-Hudson, MD, Thomas N. Bryce, MD, and Anthony Chiodo, MD, in collaboration with the University of Washington Model Systems Knowledge Translation Center.

Portions of this document were adapted from materials developed by the UAB SCI Model System, University of Michigan Model SCI Care System, Northwest Regional SCI System, and Craig Hospital.

# Pain after Spinal Cord Injury

## SUPPLEMENT: Activity Modification for Musculoskeletal Pain



For more information, contact your nearest SCI Model System. For a list of SCI Model Systems go to: <http://www.msktc.org/sci/model-system-centers>

This publication was produced by the SCI Model Systems in collaboration with the University of Washington Model Systems Knowledge Translation Center with funding from the National Institute on Disability and Rehabilitation Research in the U.S. Department of Education, grant no. H133A060070.

### Exercise

- Almost everyone can benefit from a fitness program that includes resistance training of the muscles that stabilize the shoulder. This will help prevent shoulder pain from occurring as well as treat overuse pain. Strong muscles are much less likely to be injured. Talk with your doctor or therapist about starting a program of resistance exercises that emphasizes those muscles that are often neglected during everyday activities, such as during transfers and wheelchair propulsion.
- For cardiovascular exercise, use upper limb ergometry equipment, such as a stationary bicycle powered by the arms, or a hand-cranked sports wheelchair. You can also box with a speed-bag instead of pushing a manual wheelchair for exercise. Such equipment will reduce stress on the shoulders and wrists.
- Make sure your back and shoulder muscles are strong enough to support wheeling and transferring. It is especially important that there is a balance between your left and right sides. Ask your physical therapist to evaluate you and to prescribe strengthening exercises if you need them.

### Using a Wheelchair

- Repetitive pushing of wheel rims is a major problem activity causing musculoskeletal pain. Consider obtaining a power or power-assist wheelchair if you:
  - Have significant upper limb (shoulder, elbow or hand) pain.
  - Have tetraplegia (quadriplegia).
  - Have a prior injury to an upper limb.
  - Are overweight.
  - Are elderly.
  - Live in a challenging environment such as on a steep hill or near very rough terrain.
- If you use a manual wheelchair, make sure it is the lightest model (made from aluminum or titanium) you can afford or your insurer will pay for. Lighter models give you less weight to push around and can often be customized to make it easier for you to propel the chair.
- If you do use a manual wheelchair, reduce the number of strokes you use per distance traveled. Rather than quick short pushes, use long smooth strokes.
- If you use a manual wheelchair, make sure it is in good repair and set up in a way that allows you to get around with minimal effort. Ask your

therapist to check whether your seat is in the right position relative to your rear axle. Also have him/her check that the chair and cushion together give you good stability.

- Get your wheelchair seating, posture and pushing technique evaluated by a rehab professional periodically since your needs, habits or activities may change over time.
- Keep your tires well-inflated to minimize rolling resistance.
- Wheel your chair over concrete and linoleum rather than through sand, grass or heavy carpeting. The reduced resistance to your wheels lessens the load on your arms.

## Shoulder Health

- Minimize the frequency of arm/hand tasks, especially tasks that involve lifting heavy loads higher than your shoulder. Let someone else get that book off a high shelf for you.
- If possible, do not do tasks repetitively that require you to bring your hand higher than your shoulder. This may require reorganizing your house. Talk with your occupational therapist about ways to do so.
- Minimize lifting heavy loads. If you cannot get someone else to do the heavy lifting, hold whatever you need close to your chest rather than at the end of an outstretched arm.
- Avoid doing push-up pressure reliefs (weight shifts), which can harm your shoulder joint. Instead, perform side-to-side or forward-lean pressure reliefs. Work with a therapist to learn proper technique for these methods or see the MSKTC fact sheet “How to do Pressure Reliefs (Weight Shifts)” before discontinuing push-ups.

## Transfers

- The heaviest thing you lift generally will be yourself. Reduce the number of transfers you do each day, and do them in a way that minimizes risk of injury.
- Transferring from a high point to a lower one is not as hard on your wrists, elbows

and shoulders as transferring from a low to a higher point. It is better to make two level transfers rather than one downhill transfer followed by one uphill transfer.

- Use sliding boards and other assistive devices (such as lifts) in making transfers.
- When transferring, use a handgrip if available, rather than putting your hand on a flat surface.
- When transferring, don't spread your hand flat and rest on it. Make a fist, and rest on your knuckles.
- When transferring, position your hands as closely to your body as possible so that your arms are straight up and down and your weight hangs between them.
- Alternate which one of your arms is the lead arm in transferring. Different muscles are used by the lead and trailing arms during transfers, and alternating the arms keeps muscles balanced.
- Maintain your ideal weight. Being overweight is hard on your shoulders, arms and wrists when you do transfers or push your wheelchair.

## Reference

Consortium for Spinal Cord Medicine. *Preservation of upper limb function following spinal cord injury: a clinical practice guideline for health-care professionals*. J Spinal Cord Med 2005; 28:433-70.

## Authorship

Please see the Spinal Cord Injury Model Systems Consumer Information publication *Pain after Spinal Cord Injury* for information about authorship.



# Safe Transfer Technique



For more information, contact your nearest SCI Model System. For a list of SCI Model Systems go to: <http://www.msctc.org/sci/model-system-centers>

This publication was produced by the SCI Model Systems in collaboration with the University of Washington Model Systems Knowledge Translation Center with funding from the National Institute on Disability and Rehabilitation Research in the U.S. Department of Education, grant no. H133A060070.

Transferring in and out of your wheelchair puts higher stress on your arms and shoulders than anything else you do on a regular basis. Learning the correct way to transfer is extremely important in order to keep your arms functioning and pain-free.

## Get proper transfer training

- Everyone needs individualized transfer training to preserve function and avoid injury. Work with a physical therapist to learn the best transfer technique for you and your body.
- Your transfer technique may need to be readjusted as years go by. If you develop any problems or if your living circumstances (e.g. pregnancy) or activities change, go back to your therapist for advice.

## Safe transfer rules and technique

- Frequency – Only transfer when necessary, keeping the number of transfers to a minimum.
- Transferring downhill is easier and, at modest height, safer than transferring uphill.
- Technique – Steps (These are general steps. Work with your therapist to fine tune them for you.):
  - Positioning/setup
    - Get as close as possible to the surface you want to move to.
    - Lock your wheels if transferring from a wheelchair.
    - Put your feet on floor (unless your therapist tells you not to).
    - Scoot to the edge of your chair.
    - Get your arm rest out of the way on the side next to the surface you are transferring to.



*continued on page 2*



- Lean your trunk forward.
  - When transferring, your head should move in the opposite direction of your hips. This is known as a head-hips relationship and can help with movement and clearing obstacles.
- To protect your shoulders, keep your arms as close to your body as possible (about 30–45 degrees away from your body) while you are lifting your weight.
- To protect your wrists, try to grip an edge or grab bar with your fingers rather than laying your hands flat. Keeping your hands flat and putting your weight on your palms is a dangerous position that can lead to wrist problems such as carpal tunnel syndrome down the road.
- Lift-off
  - Make sure you are clearing obstacles (not bumping or rubbing) to avoid shearing and pressure sores.
  - If you cannot perform the transfer in one smooth movement while keeping your arms close to your body, move in several small “steps” and/or use a transfer board.
  - Be careful sliding across the transfer board because the motion can damage your skin. Use a pad or towel on the board when bare skin may come in contact with the board during the transfer.
- Alternate leading arms and direction of transfers to keep your arm muscles balanced and reduce strain on one side.
- Maintain ideal body weight. The more you weigh, the more weight you have to transfer and the more stress you put on your shoulders and arms.
- If you are unable to perform a transfer safely or are at risk for developing arm pain, you should strongly consider using one of the many kinds of patient lifts available.

## Resources

Consortium for Spinal Cord Medicine. *Preservation of Upper Limb Function: What You Should Know. A Guide for People with Spinal Cord Injury*, Paralyzed Veterans of America, 2008.

## Source

Our health information content is based on research evidence whenever available and represents the consensus of expert opinion of the SCI Model System directors.

## Authorship

*Safe Transfer Technique* was developed by Michael L. Boninger, MD, in collaboration with the University of Washington Model Systems Knowledge Translation Center.

## Disclaimer

This information is not meant to replace the advice from a medical professional. You should consult your health care provider regarding specific medical concerns or treatment.



# Skin Care & Pressure Sores

## Part 1: Causes and Risks of Pressure Sores



For more information, contact your nearest SCI Model System. For a list of SCI Model Systems go to: <http://www.msctc.org/sci/model-system-centers>

This publication was produced by the SCI Model Systems in collaboration with the University of Washington Model Systems Knowledge Translation Center with funding from the National Institute on Disability and Rehabilitation Research in the U.S. Department of Education, grant no. H133A060070.

### What do I need to know?

- Individuals with SCI are at high risk for developing pressure sores.
- **Pressure sores can be life threatening.**
- Possible complications:
  - Infections can develop and spread to the blood, heart and bone.
  - Amputations
  - Prolonged bed rest necessary for healing can keep you out of work, school and social activities for months.
  - Because you are less active when healing a pressure sore, you are at higher risk for respiratory problems and urinary tract infections.
  - Treatment can be very costly in lost wages or additional medical expenses.
- Up to 80% of individuals with SCI will have a pressure sore during their lifetime, and 30% will have more than one pressure sore.
- Most pressure sores are preventable.

### What is a pressure sore?

A pressure sore (also called pressure ulcer, decubitus ulcer, decubiti (plural), bedsore or skin breakdown) is an area of the skin or underlying tissue (muscle, bone) that is damaged due to loss of blood flow to the area. Blood flow to the skin keeps it alive and healthy. If the skin does not get blood, it will die.

### Why do pressure sores happen?

Normally the nerves send messages of pain or discomfort to your brain to let you know when to move to relieve pressure, stay away from hot surfaces, or shift your weight. After injury, messages from the sensory nerves may not normally reach the brain. With little or no feeling, you have no warning signs to tell you that you have been in one position too long and that something is pressing against your skin causing it harm.

### How do pressure sores happen?

- **Too much pressure on the skin for too long**, as in sitting or lying too long in one position. Unrelieved pressure is the most common cause of pressure sores in SCI. The extended pressure cuts off the blood supply to the skin, leading to tissue damage, skin breakdown and a pressure sore. Common high-pressure situations:
  - Sitting too long without shifting weight.
  - Lying too long without turning.
  - Not enough padding in bed (to protect bony areas of the body, such as the heels).

- Clothing and shoes that fit too tightly.
- Sitting or lying on hard objects, such as catheter connectors and clamps, bulky seams, or buttons on mattresses.
- **Shearing** occurs when the skin moves one way and the bone underneath it moves another way. This can result from slouching while sitting, sitting at a 45 angle (as in bed), or sliding during a transfer instead of lifting your body. Shearing can also happen during spasms.
- **Trauma** of any kind (cuts, bumps, burns, scrapes, rubbing)
  - **Abrasion or friction:** Cut or scratch; sliding across sheets or transfer board with bare skin.
  - **Bump or fall:** Bumping toes into doorways; bumping your buttocks off the tire during transfers; bumping knees under desks.

## What puts me at risk of getting a pressure sore?

- **Loss of muscle mass.** With paralysis the muscles tend to shrink, become less bulky and get smaller (atrophy). Muscle mass or bulk serves as a natural cushion over the bony areas. A decrease in muscle mass leads to less protection over bony surfaces and more pressure on the thin skin layers.
- **Being over- or underweight.** When you are underweight, you have less natural padding to protect your body areas, so your skin can break down from even small amounts of pressure. But when you are overweight, it is harder to shift your weight and do pressure reliefs, and all that fat uses oxygen and nutrients that could be nourishing your skin.
- **Decreased circulation.**
  - **Blood flow to the paralyzed limbs decreases** due to the lack of muscle movement and results in less nutrients and oxygen getting to the skin. The skin does not heal well if there is poor circulation.
  - **Edema or swelling** is caused by fluid collecting in the tissues, usually in a part of the body that is not moved frequently and is below the level of the heart (feet, legs and hands). Skin over areas of edema becomes thin and pale and injures easily.

- **Smoking** is terrible for your circulation.
- **Diabetes, high blood pressure and high cholesterol** decrease circulation. If you have these diseases, pay particular attention to your feet and ankles. They are farthest away from the heart and are likely to be affected first or worst.
- **Illness or poor overall health.** This includes fevers, infections (such as UTIs), poor nutrition, and chronic diseases such as diabetes.
- **Moisture.** Wet skin (from urine, stool, sweat, water) is more likely to break down.
- **Dry, flaky skin** can crack and become inflamed and infected.
- **Agging** causes skin to become thinner, dryer, and more fragile. You may need to adjust your pressure relief schedule or switch to a different type of cushion when you get older.
- **Previous skin breakdown.** Scar tissue is more fragile than normal skin.
- **Spasticity** can cause your arms or legs to bump against an object and be injured, or rub against a surface (such as the sheets on your bed), which could produce an open sore.
- **Extreme heat or cold.**
- **Alcohol (or drug) use** often causes people to neglect their pressure reliefs and other personal care needs.
- **Depression** is also a risk factor for developing pressure sores.

## Source

Our health information content is based on research evidence and/or professional consensus and has been reviewed and approved by an editorial team of experts from the SCI Model Systems.

## Authorship

This brochure was developed by the SCI Model System Dissemination Committee in collaboration with the University of Washington Model Systems Knowledge Translation Center.

## More in the Skin Care & Pressure Sores series:

- Part 2: Preventing Pressure Sores
  - Supplements:*
    - How to do Pressure Reliefs (Weight Shifts)
    - Building Skin Tolerance for Pressure
    - Areas of the Body at High Risk for Pressure Sores
- Part 3: Recognizing and Treating Pressure Sores
  - Supplements:*
    - Stages of Pressure Sores: Illustrations

# Skin Care & Pressure Sores

## Part 2: Preventing Pressure Sores



For more information, contact your nearest SCI Model System. For a list of SCI Model Systems go to:

<http://www.msktc.org/scimodel-system-centers>

This publication was produced by the SCI Model Systems in collaboration with the University of Washington Model Systems Knowledge Translation Center with funding from the National Institute on Disability and Rehabilitation Research in the U.S. Department of Education, grant no. H133A060070.

### What do I need to know?

- Ninety-five percent of all pressure sores are preventable!
- After spinal cord injury, your skin requires daily care and a lot of attention.
- You will need to spend time daily cleaning the skin, keeping it dry (from incontinence or perspiration), checking the skin for problems or changes, moving yourself so the skin will get proper blood supply, and drinking and eating properly so the skin can stay healthy.

### How can I avoid getting a pressure sore?

Do regular pressure reliefs (also called weight shifting, pressure redistribution and pressure reduction)

- Pressure relief is moving or lifting yourself to take the pressure off areas that have been under pressure, usually from sitting or lying in one position, so blood can circulate.
- When sitting in your wheelchair you should do pressure reliefs every 15 to 30 minutes for a duration of at least 30 to 90 seconds. Continue to perform pressure reliefs when sitting in a car or on other surfaces (such as on sports equipment). [For more information, read the fact sheet on “How to do Pressure Reliefs (Weight Shifts).”]
- If you are unable to perform a pressure relief independently, instruct the person who helps you with your daily care (family, attendant) to consistently, routinely move you and reduce pressure over areas at risk for pressure sores.
- Your therapist or nurse will teach you how to do pressure reliefs before you leave the hospital. The methods and timing of pressure reliefs will vary somewhat according to your injury and skin tolerance.
- Each person’s skin tolerance is different. Some people may need to relieve pressure very often, others may not need to do it very often—but they still need to do it! Building skin tolerance is a gradual process. [For more information, read the fact sheet on “Building Skin Tolerance for Pressure.”]
- For pressure relief at night, see the recommendations described in “Padding, positioning and turning in bed,” below.

## Skin inspection

- Check your skin, or have your attendant or caregiver check your skin, a minimum of twice a day (morning and bedtime).
- Look for changes in skin color (redness or darkening), blisters, bruises, cracked, scraped or dry skin.
- Feel for hardness, swelling or warmth that may signal skin breakdown.
- Closely inspect areas that are at especially high risk for pressure sores because in some areas of the body the bones are close to the surface of the skin; the skin that is directly over bone is at highest risk. [For more information, read the fact sheet on “Areas at High Risk for Developing Pressure Sores.”]:
  - sacrum (lower back)
  - coccyx (tailbone)
  - heel of the foot
  - ischium (the base of the buttocks, “seat bones”)
  - trochanter (hip, from lying on side, something rubbing, or tight clothes)
  - elbow (from leaning on it)
  - knee (from spasms or side-lying with one knee on top of other)
  - ankle (from lying on side)
  - toes and bony areas of foot (from tight-fitting shoes)
  - back of the head
- Inspect areas of skin that are in contact with casts or braces twice daily.
- Use a mirror to inspect skin in hard-to-see areas. Train the person who helps you to carefully and regularly check your skin.
- Pay attention to fingernails and toenails: an ingrown toenail or cut along your nail bed may lead to a sore which can easily be infected.
- As soon as you notice a discolored area, stay off the area until it returns to normal skin color.
- If you suspect skin damage of any kind, read the fact sheet “Skin Care & Pressure Sores, Part 3: Recognizing and Treating Pressure Sores.”

## Padding, positioning and turning in bed

- Use a regular schedule of turning at night. Depending on weight and skin tolerance, your turning schedule may vary from every 2 to every 6 hours. Ask your health care provider for advice about a turning schedule. When turning and moving in bed, lift rather than slide across sheets.
- Use pillows and foam pads (not folded towels or blankets) to protect bony areas. No two skin surfaces should rest against each other!
- Unless your doctor tells you to do it, avoid elevating the head of your bed, which can put too much pressure on your buttocks and lower back areas.
- For individuals at the highest risk for pressure sores, your health care provider may prescribe a special mattress, mattress overlay or bed for long-term use.

## Keep skin clean and dry

- Bathe daily with mild soap and warm water and rinse and dry thoroughly. Pay particular attention to keeping the genital area and skin folds clean and dry.
- Immediately wash and dry skin and change clothing after any leakage of stool or urine.
- Avoid harsh soaps, skin agents with alcohol, and antibacterial or antimicrobial soaps. Do not use powders. Use a moisturizer that has been approved by your health care provider.

## Get a proper seating evaluation at least every two years or sooner if your health or skin condition changes.

- Make sure you have the proper cushion for your wheelchair and your seating tolerance.
- Make sure you have the appropriate wheelchair, one that has been measured specifically for you and is compatible with your level of mobility, activities, work and associated equipment.
- The therapist doing the seating evaluation should place a pressure map above your cushion and under your buttocks to see where

your pressure-sensitive areas are. If at-risk areas on the pressure map are found, then the therapist may try a different cushion; alter the wheelchair seat, back or foot rest; or show you how to relieve pressure on the vulnerable areas by repositioning your body.

- Pressure mapping is an excellent way to visually demonstrate the effectiveness of weight shifts.
- If pressure mapping is unavailable, work with a seating professional and try several different cushions to see what works best for you.

## Positioning and transferring

- Sit as erect as possible in your wheelchair. Slouching can damage skin.
- Perform safe transfers. Do not drag or scrape your bottom when moving in and out of your wheelchair.
- If you need help during transfers, make sure the person who is helping you is very well trained to assist.

## Clothing, shoes

- Wear properly fitted clothing; avoid thick seams, rivets or bulky pockets and check for folds and wrinkles in areas of pressure.
- Shoes should be 1-2 sizes longer and wider than your pre-injury shoe size to allow for swelling of feet during the day.
- Use shoes with stiffer toes for protection when you bump into objects with your feet.
- Do not carry anything (comb, wallet, etc.) in your back pockets.

## Hydration (fluid intake)

- Drink enough water every day to give your body the fluids it needs. Water intake may vary according to your bladder management routine—consult your health care provider for advice about how much water to drink.
- Avoid caffeinated drinks like coffee, tea and soft drinks, which are dehydrating and may trigger bladder spasms.

## Nutrition

- Eat a balanced diet that includes adequate protein, fruits and vegetables (fresh if possible). Poor nutrition prevents the body tissue from rebuilding, staying healthy and fighting infection.
- If there is any question about your nutritional status you may ask your doctor to order a blood test to check your protein, albumen, prealbumen, lymphocyte or hemoglobin levels.
- If you have any conditions that may be affected by your nutrition (such as diabetes or hypertension), please consult with your health care provider who may recommend a consultation with a dietician.
- More information about nutrition and spinal cord injury:
  - “Nutritional Guidelines for Individuals with Spinal Cord Injury.” Northwest Regional Spinal Cord Injury System. (2006) <http://sci.washington.edu/info/forums/reports/nutrition.asp>.
  - “Weight Management Following SCI - SCI InfoSheet #8.” Discusses the role of nutrition in an overall weight management program. Spinal Cord Injury Information Network (2005). <http://www.spinalcord.uab.edu/show.asp?durki=21481>

## Sun exposure

- Avoid getting sunburned. Some medicines make your skin more sensitive and may cause it to burn more easily. Use sunscreen and limit your time in the sun, or seek shade.

## Equipment

- Use prescribed, individualized equipment when seated or lying down. Have a doctor or qualified professional recommend what specialized equipment (seat cushion, mattress, pillows) you need to protect your skin.
- Check wheelchair, mattress, cushions and transfer boards daily for problems. Maintain, at a minimum, the manufacturer’s recommendations for maintenance of all equipment.

## Temperature

- Compared to before your injury, you are more susceptible to frostbite in cold weather due to changes in circulation and lack of sensation.
- You are also more susceptible to burns. Avoid contact with hot objects (metal pipes, fireplaces, heater in your home or car, hot water in the shower, microwaved dishes or food items you might want to place on your lap).

## Circulation

- Quit smoking!
- Keep as active as possible.

## Source

Our health information content is based on research evidence and/or professional consensus and has been reviewed and approved by an editorial team of experts from the SCI Model Systems.

## Authorship

This brochure was developed by the SCI Dissemination Committee in collaboration with the University of Washington Model Systems Knowledge Translation Center. Portions of this document were adapted from materials produced by the SCI Model Systems.

## *The Skin Care and Pressure Sores series:*

- Part 1: Causes and Risks of Pressure Sores
- Part 2: Preventing Pressure Sores  
*Supplements:*
  - How to do Pressure Reliefs (Weight Shifts)
  - Building Skin Tolerance for Pressure
  - Areas of the Body at High Risk for Pressure Sores
- Part 3: Recognizing and Treating Pressure Sores  
*Supplements:*
  - Stages of Pressure Sores: Illustrations



**Spinal Cord Injury Model System**  
**SCIMS | NIDRR**  
A NIDRR Funded Program

# Skin Care & Pressure Sores

## Part 2: Preventing Pressure Sores

### Supplement: Areas at high risk of developing pressure sores



For more information, contact your nearest SCI Model System. For a list of SCI Model Systems go to: <http://www.msktc.org/sci/model-system-centers>

This publication was produced by the SCI Model Systems in collaboration with the University of Washington Model Systems Knowledge Translation Center with funding from the National Institute on Disability and Rehabilitation Research in the U.S. Department of Education, grant no. H133A060070.

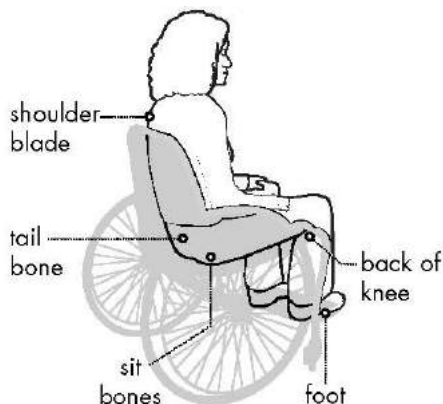

Areas where bones are close to the surface (called “bony prominences”) and areas that are under the most pressure are at greatest risk for developing pressure sores.

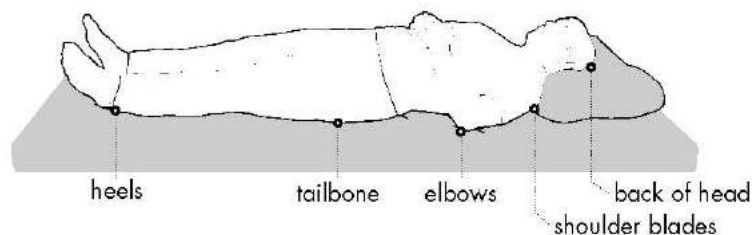

In bed, body parts can be padded with pillows or foam to keep bony prominences (areas where bones are close to the skin surface) free of pressure. Place a pillow between the knees while sleeping on your side to prevent

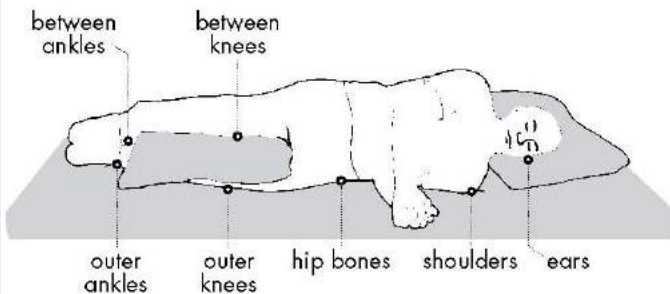

skin-to-skin contact and increase air circulation between your legs.

*Illustrations from the Northwest Regional SCI System (2006).*

#### Source

Our health information content is based on research evidence and/or professional consensus and has been reviewed and approved by an editorial team of experts from the SCI Model Systems.

#### Authorship

This brochure was developed by the SCI Model System Dissemination Committee in collaboration with the University of Washington Model Systems Knowledge Translation Center. Portions of this document were adapted from materials produced by the SCI Model Systems.



# Skin Care & Pressure Sores

## Part 2: Preventing Pressure Sores

### Supplement: Building skin tolerance for pressure



For more information, contact your nearest SCI Model System. For a list of SCI Model Systems go to: <http://www.msctc.org/scimodel-system-centers>

This publication was produced by the SCI Model Systems in collaboration with the University of Washington Model Systems Knowledge Translation Center with funding from the National Institute on Disability and Rehabilitation Research in the U.S. Department of Education, grant no. H133A060070.

#### What is skin tolerance?

Skin tolerance is how much time your skin can stand to be under pressure before damage starts to occur. Each person's skin tolerance is different. Some people may need to relieve pressure very often, others may not have to do it as often, but they still need to do it!

Skin tolerance changes if you are sick, not eating well, have changes in posture or you change the surface you sit or lie on. Inspect your skin more frequently under these circumstances.

#### How do I know what my skin can tolerate?

When you were in the hospital, the staff worked with you daily to help you build skin tolerance and know what limits your skin can handle. Discuss skin tolerance with your physician or seating specialist if you have questions.

The increase in redness of your skin after applying pressure (the first sign of a pressure sore) and the amount of time it takes for the redness to fade will tell you what your skin can tolerate and whether to increase your time between pressure reliefs.

Remember, no matter how many hours you sit in a wheelchair, you need to move yourself every 15 to 30 minutes.

#### How do I know if I can increase sitting time or time in one position?

- Building up skin tolerance is a gradual process. You can build skin tolerance for any position, lying down or sitting, by following these steps:
  - Lie in one position for the amount of time advised by your doctor.
  - Look at your skin. Test if the pink areas of you skin turn white when touched.
  - Stay off the area until the redness or pinkness clears completely.
  - If redness or pinkness clears in 15-30 minutes, you may increase your time between pressure reliefs or turning by 30 minutes.
  - If redness or pinkness does not clear in 15-30 minutes, do not increase your time between pressure reliefs or turning.

#### Source

Our health information content is based on research evidence and/or professional consensus and has been reviewed and approved by an editorial team of experts from the SCI Model Systems.

#### Authorship

This brochure was developed by the SCI Model System Dissemination Committee in collaboration with the University of Washington Model Systems Knowledge Translation Center. Portions of this document were adapted from materials produced by the SCI Model Systems.

# Skin Care & Pressure Sores

## Part 2: Preventing Pressure Sores

### Supplement: How to do pressure reliefs (weight shifts)



For more information, contact your nearest SCI Model System. For a list of SCI Model Systems go to: <http://www.msktc.org/sci/model-system-centers>

This publication was produced by the SCI Model Systems in collaboration with the University of Washington Model Systems Knowledge Translation Center with funding from the National Institute on Disability and Rehabilitation Research in the U.S. Department of Education, grant no. H133A060070.

The pressure relief technique you use will depend on your level of injury, the type of wheelchair you use and how much movement and strength you have in your arms and shoulders.

### Tilting or reclining

- If you are unable to perform independent pressure reliefs, you can use a power tilt wheelchair for regular pressure relief.
- Tilt, recline and elevating leg rests are features that can be used to change body position in a manner that provides pressure relief.
- It is very important that you receive training from your health care provider in how to use any of these features in order to make sure you are getting enough pressure relief. Improper use of these features can also lead to injury.
- Note that tilt and recline features provide the most pressure relief when used in combination. (RESNA, 2008)
- **Tilt systems** maintain the seat to back angle but change the angle orientation to the ground. Tilt angle of between 25 and 65 degrees has been shown to provide pressure relief, but 15 degrees or less does not provide adequate pressure relief. Figure 1 shows a 65 degree tilt.
- **Recline systems** (Figure 2) provide a change in seat-to-back angle while maintaining a constant seat angle with respect to the ground. The use of recline affects the vertical (downward) pressure and horizontal pressure on your skin and needs to be evaluated individually.
- **Elevating leg rests** allow change in the angle of legs and/or footrests in relation to the seat, extending the knee. This feature can help reduce pressure when using the recline feature.

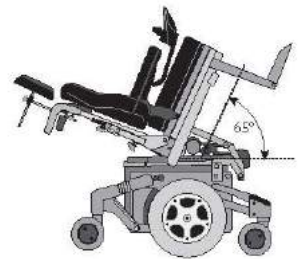

Figure 1: Tilt System

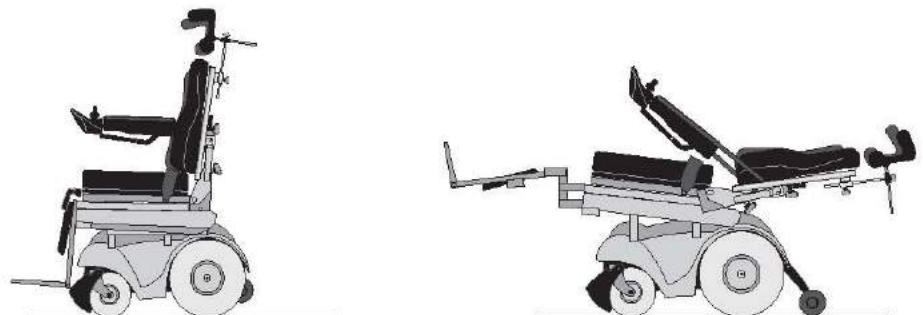

Figure 2: Recline System

## Leaning from side to side

This technique relieves pressure over one buttock at a time.

1. **Lock your wheels**, and swing away one armrest from your wheelchair.



Figure 3



Figure 4

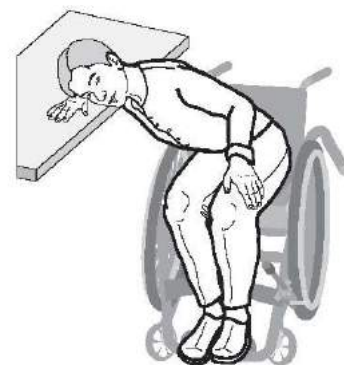

Figure 5

2. Hold onto the remaining armrest and lean your body to the opposite side, taking the weight off one buttock for 30-90 seconds (Figure 3). If you cannot grasp the armrest with your hand, you may be able to hook your wrist behind the wheelchair push handle or back rest (Figure 4).
3. To regain the upright position, you may need to use the wheelchair push handle or armrest for assistance. Some also find that pushing up on the push rims of the wheels helps in regaining upright position.
4. You may use a table or other stationary object to lean against for assistance (Figure 5). Just be sure the weight is completely off the opposite buttock, and hold the position for 30-90 seconds.
5. Repeat on the other side.

## Leaning forward

This technique can be done independently or with assistance.

1. Move your wheelchair so that **the front casters are turned forward**, then **lock the wheels** of your wheelchair.
2. Bend forward and bring your chest to your knees (Figure 6). This lifts the weight of your bottom from the wheelchair. Stay in this position for 30-90 seconds.
3. Return your body to the upright position. There are several techniques to regain upright position depending on your equipment and the strength in your arms and trunk. You may:
  - Place your hand on your knees and push up.
  - Keep your hand on push handles and pull up.
  - Place your hand against the front of the armrest and push up.



Figure 6

## Independent push-ups

This technique can be used by individuals who can extend their elbows and lift their body weight (people with an injury at C7 and below). Grip your arm rests with your hands and lift up completely off your seat for 60 seconds. Since this method could harm the rotator cuff (part of the shoulder joint), it should only be used if you are unable to complete the other techniques.

## Progression of Training

Early in your training, you may find that it is difficult to shift your weight away from the center of your chair. It may also be difficult for you to regain upright position after shifting your weight. You may try the following techniques.

- Position and lock your chair next to a stationary object. Perform the side lean as instructed above, but use the object to push up as you regain the upright position.
- Position and lock your chair in front of a table. Lean forward onto the table and use it to push back up.

## Alternate Techniques

If you are looking for less obvious pressure relief techniques when you are out in the community, the following suggestions can be done without attracting attention.

- Cross one leg over the other and lean back to one side while holding your knee in position, lifting the weight off one buttock (Figure 7). Repeat using the other leg.
- Cross your leg by putting one ankle over the other knee and lean forward, lifting the weight off your buttock (Figure 8). Repeat using the other leg.
- Spend some time “fixing” your shoe laces, your feet, or the hem of your pants to achieve the same position as the forward lean technique (Figure 6).
- Lean against tables as you speak to friends.



Figure 7



Figure 8

## References

*Resna Position on the Application of Tilt, Recline and Elevating Legrests*, Rehabilitation Engineering & Assistive Technology Society of North America. Arlington, VA. April 2008.

## Source

Our health information content is based on research evidence and/or professional consensus and has been reviewed and approved by an editorial team of experts from the SCI Model Systems.

## Authorship

This brochure was developed by the SCI Model System Dissemination Committee in collaboration with the University of Washington Model Systems Knowledge Translation Center. Portions of this document were adapted from materials produced by the SCI Model Systems.

# Skin Care & Pressure Sores

## Part 3: Recognizing and Treating Pressure Sores



For more information, contact your nearest SCI Model System. For a list of SCI Model Systems go to:

<http://www.msctc.org/scimodel-system-centers>

This publication was produced by the SCI Model Systems in collaboration with the University of Washington Model Systems Knowledge Translation Center with funding from the National Institute on Disability and Rehabilitation Research in the U.S. Department of Education, grant no. H133A060070.

### How can I tell if I have a pressure sore?

- **First signs.** One of the first signs of a possible skin sore is a reddened, discolored or darkened area (an African American's skin may look purple, bluish or shiny). It may feel hard and warm to the touch.
- **A pressure sore has begun** if you remove pressure from the reddened area for 10 to 30 minutes and the skin color does not return to normal after that time. **Stay off the area** and follow instructions under Stage 1, below. Find and correct the cause immediately.
- **Test your skin with the blanching test:** Press on the red, pink or darkened area with your finger. The area should go white; remove the pressure and the area should return to red, pink or darkened color within a few seconds, indicating good blood flow. If the area stays white, then blood flow has been impaired and damage has begun.
- **Dark skin** may not have visible blanching even when healthy, so it is important to look for other signs of damage like color changes or hardness compared to surrounding areas.
- **Warning:** What you see at the skin's surface is often the smallest part of the sore, and this can fool you into thinking you only have a little problem. But skin damage from pressure doesn't start at the skin surface. Pressure usually results from the blood vessels being squeezed between the skin surface and bone, so the muscles and the tissues under the skin near the bone suffer the greatest damage. Every pressure sore seen on the skin, no matter how small, should be regarded as serious because of the probable damage below the skin surface.

### Stages of pressure sores

[Also see "Stages of Pressure Sores: Illustrations."]

#### STAGE 1

- **Signs:** Skin is not broken but is red or discolored or may show changes in hardness or temperature compared to surrounding areas. When you press on it, it stays red and does not lighten or turn white (blanch). The redness or change in color does not fade within 30 minutes after pressure is removed.
- **What to do:** Stay off the area and remove all pressure; keep the area clean and dry; eat adequate calories high in protein, vitamins (especially A and C) and minerals (especially iron and zinc); drink more water; find and remove the cause; inspect the area at least twice a day; call your health care provider if it has not gone away in 2-3 days.
- **Healing time:** A pressure sore at this stage can be reversed in about three days if all pressure is taken off the site.

## STAGE 2

- **Signs:** The topmost layer of skin (epidermis) is broken, creating a shallow open sore. The second layer of skin (dermis) may also be broken. Drainage (pus) or fluid leakage may or may not be present.
- **What to do:** Get the pressure off, follow steps in Stage 1, and see your health care provider right away.
- **Healing time:** Three days to three weeks.

## STAGE 3

- **Signs:** The wound extends through the dermis (second layer of skin) into the fatty subcutaneous (below the skin) tissue. Bone, tendon and muscle are not visible. **Look for signs of infection** (redness around the edge of the sore, pus, odor, fever, or greenish drainage from the sore) and possible necrosis (black, dead tissue).
- **What to do:** If you have not already done so, get the pressure off and see your health care provider right away. Wounds in this stage frequently need special wound care. You may also qualify for a special bed or pressure-relieving mattress that can be ordered by your health care provider.
- **Healing time:** One to four months.

## STAGE 4

- **Signs:** The wound extends into the muscle and can extend as far down as the bone. Usually lots of dead tissue and drainage are present. **There is a high possibility of infection.**
- **What to do:** Always consult your health care provider right away. Surgery is frequently required for this type of wound.
- **Healing time:** Anywhere from three months to two years.

## SUSPECTED DEEP TISSUE INJURY \*

- Purple or maroon localized area of discolored intact skin or blood-filled blister due to damage of underlying soft tissue from pressure and/or shear. The area may be surrounded by tissue that is painful, firm, mushy, boggy, warmer or cooler as compared to nearby tissue.
- Deep tissue injury may be difficult to detect in individuals with dark skin tones. Progression may include a thin blister over a dark wound

bed. The wound may further evolve and become covered by thin eschar (scab). Progression may be rapid exposing additional layers of tissue even with optimal treatment.

## UNSTAGEABLE \*

- Full thickness tissue loss in which the base of the ulcer is covered by slough (dead tissue separated from living tissue) of yellow, tan, gray, green or brown color, and/or eschar (scab) of tan, brown or black color in the wound bed.

\* From: Pressure Ulcer Stages Revised by National Pressure Ulcer Advisory Panel (2007). <<http://www.npuap.org>>.

## Possible complications of pressure sores:

- **Can be life threatening.**
- Infection can spread to the blood, heart and bone.
- Amputations.
- Prolonged bed rest that can keep you out of work, school and social activities for months.
- Autonomic dysreflexia.
- Because you are less active when healing a pressure sore, you are at higher risk for respiratory problems or urinary tract infections (UTIs).
- Treatment can be very costly in lost wages or additional medical expenses.

## Source

Our health information content is based on research evidence and/or professional consensus and has been reviewed and approved by an editorial team of experts from the SCI Model Systems.

## Authorship

This brochure was developed by the SCI Dissemination Committee in collaboration with the University of Washington Model Systems Knowledge Translation Center. Portions of this document were adapted from materials produced by the SCI Model Systems.

## The *Skin Care and Pressure Sores* series:

- Part 1: Causes and Risks of Pressure Sores
- Part 2: Preventing Pressure Sores  
*Supplements:*
  - How to do Pressure Reliefs (Weight Shifts)
  - Building Skin Tolerance for Pressure
  - Areas of the Body at High Risk for Pressure Sores
- Part 3: Recognizing and Treating Pressure Sores  
*Supplements:*
  - Stages of Pressure Sores: Illustrations

# Skin Care & Pressure Sores

## Part 3: Recognizing and Treating Pressure Sores

### Supplement: Stages of Pressure Sores: Illustrations



For more information, contact your nearest SCI Model System. For a list of SCI Model Systems go to: <http://www.msctc.org/sci/model-system-centers>

This publication was produced by the SCI Model Systems in collaboration with the University of Washington Model Systems Knowledge Translation Center with funding from the National Institute on Disability and Rehabilitation Research in the U.S. Department of Education, grant no. H133A060070.

#### NORMAL SKIN

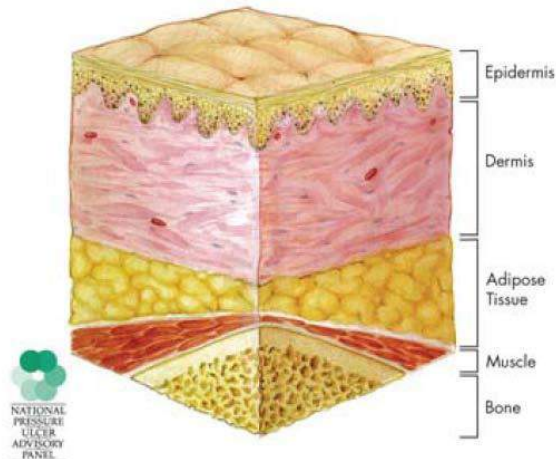

#### STAGE 1

Skin is not broken but is red or discolored. When you press it, it stays red and does not lighten or turn white (blanch). The redness or change in color does not fade within 30 minutes after pressure is removed.

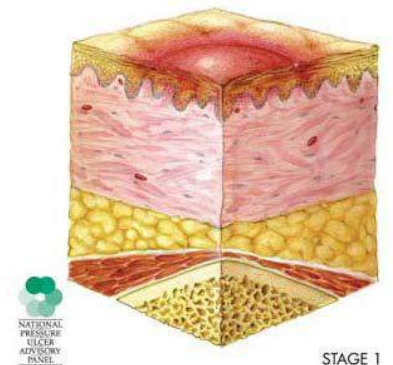

STAGE 1

#### STAGE 2

The topmost layer of skin (epidermis) is broken, creating a shallow open sore. The second layer of skin (dermis) may also be broken. Drainage may or may not be present.

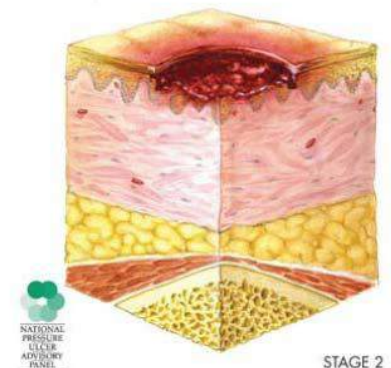

STAGE 2

## STAGE 3

The wound extends through the dermis (second layer of skin) into the subcutaneous (below the skin) fat tissue. Bone, tendon and muscle are not visible. Look for signs of infection (pus, drainage) and possible necrosis (black, dead tissue).

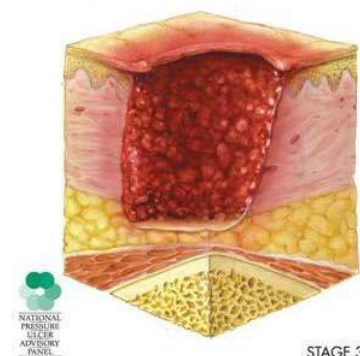

STAGE 3

## STAGE 4

The wound extends into the muscle and can extend as far down as the bone. Usually lots of dead tissue and drainage are present. There is a high possibility of infection.

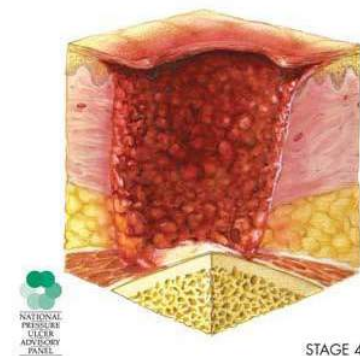

STAGE 4

Illustrations are from the National Pressure Ulcer Advisory Panel (<http://www.npuap.org/>).

## Source

Our health information content is based on research evidence and/or professional consensus and has been reviewed and approved by an editorial team of experts from the SCI Model Systems.

## Authorship

This brochure was developed by the SCI Model System Dissemination Committee in collaboration with the University of Washington Model Systems Knowledge Translation Center. Portions of this document were adapted from materials produced by the SCI Model Systems.





# Spasticity and Spinal Cord Injury



For more information, contact your nearest SCI Model System. For a list of SCI Model Systems go to: <http://www.msctc.org/sci/model-system-centers>

This publication was produced by the SCI Model Systems in collaboration with the University of Washington Model Systems Knowledge Translation Center with funding from the National Institute on Disability and Rehabilitation Research in the U.S. Department of Education, grant no. H133A060070.

## What is spasticity?

Spasticity is the uncontrolled tightening or contracting of the muscles that is common in individuals with spinal cord injuries. About 65%–78% of the SCI population have some amount of spasticity, and it is more common in cervical (neck) than thoracic (chest) and lumbar (lower back) injuries.

Symptoms and severity of spasticity vary from person to person and can include:

- Sudden, involuntary flexing (bending) or extending (straightening) of a limb, or jerking of muscle groups such as in the trunk (chest, back, and abdomen), bladder, or rectum.
- Hyperactive (overactive) reflexes, such as a muscle spasm when you are lightly touched.
- Stiff or tight muscles at rest, so that it is difficult to relax or stretch your muscles.
- Muscle tightness during activity, making it difficult for you to control your movement.

## What causes spasticity?

The nerves of the spinal cord and brain form a complex communication circuit that controls our body movements. Information on sensations or processes such as touch, movement or muscle stretch is sent up the spinal cord to the brain. In response, the brain interprets the signal and sends the necessary commands back down the spinal cord to tell your body how to react. The reaction of the body, such as jerking away from a hot object, is a reflex and happens quickly and automatically.

After a spinal cord injury, the normal flow of signals is disrupted, and the message does not reach the brain. Instead, the signals are sent back to the motor cells in the spinal cord and cause a reflex muscle spasm. This can result in a twitch, jerk or stiffening of the muscle.

Just about any touch, movement or irritation can trigger and sustain spasms.

### Common triggers are:

- Stretching your muscles.
- Moving your arm or leg.
- Any irritation to the skin, such as rubbing, chafing, a rash, in-grown toenails, or anything that would normally be very hot or cold or cause pain.
- Pressure sores.
- A urinary tract infection or full bladder.

- Constipation or large hemorrhoids.
- Fracture or other injury to the muscles, tendons or bone below the level of spinal cord injury.
- Tight clothing, wraps or binders.

Spasticity can be irritating, inconvenient or even limit your ability to go through your day.

## What are the benefits of spasticity in SCI?

Spasticity is not always harmful or bothersome and does not always need to be treated. Sometimes spasticity can help with functional activities such as standing or transferring. Spasticity that causes your fingers to bend can help you grip objects. Spasticity can also be a signal that you have a medical problem that you might not know about otherwise, such as a urinary tract infection, fracture, or pressure sore.

## What problems are caused by spasticity?

- Spasticity can be painful.
- Spasticity can result in loss of range of motion in your joints (contractures).
- Severe spasms can make it difficult for you to drive or transfer safely, or to stay properly seated in your wheelchair.
- Spasticity in your chest muscles may make it difficult to take a deep breath.
- Strong spasms in the trunk or legs can cause you to fall out of your wheelchair when you change position, transfer, or ride over uneven surfaces.
- Repeated muscle spasms at night can cause you to sleep poorly and be tired during the day.
- Spasms can cause rubbing that leads to skin breakdown.
- Spasticity can make movement harder to control, so that activities such as feeding yourself may be more difficult.

## Managing spasticity after SCI

First, practice healthy behaviors and good self-care that will help you avoid problems that can increase spasticity, such as urinary tract infections and skin breakdown. Check to see if any of the common triggers listed above may be causing the problem.

## Physical treatments

The following treatments will help to maintain flexibility and therefore reduce spasticity and the risk for permanent joint contracture:

- Regular stretching (range-of-motion) exercises twice daily will help maintain flexibility and temporarily reduce muscle tightness.
- Weight-bearing or standing with support, such as using a standing frame or other supportive devices, will help stretch muscles.
- Splints, braces, or progressive casting into the desired position provides continuous muscle stretching that helps to maintain flexibility and a position that does not trigger a spasm.
- Careful use of hot or cold packs. When used in body areas that have partial sensation, check skin tolerance frequently as it may result in a burn if too hot and frostbite if too cold. Avoid the use of hot packs over areas without sensation.

## Medications

When physical measures are not enough to control spasticity, medications may be needed.

### ▪ Oral medications

If spasticity involves large areas of your body, your doctor may prescribe one or more of the following medications:

- Baclofen
- Benzodiazepines (muscle relaxants) such as diazepam, clonazepam
- Dantrolene
- Tizanidine

The effectiveness of these medications varies with each person. Because these medications can have side effects such as fatigue or drowsiness, weakness, nausea, or sometimes low blood pressure, your provider needs to monitor you closely.

### ▪ Nerve or motor point blocks

If only part of your body has spasticity, anesthetic medications, alcohol, phenol or neurotoxins (such as strains of botulinum toxin) can be injected into the muscles that have spasticity. The medications rarely cause widespread side-effects. The benefits of the injections are only temporary, however, so injections must be repeated a few times a year. These injections can be used alone or in combination with oral spasticity medications.

## Surgery

### ▪ Intrathecal medication therapy (also called a “pump” or “baclofen pump”)

Intrathecal drug therapy uses a surgically placed, battery-powered pump and an attached catheter to deliver medication directly into the spinal canal, around the spinal cord (called the “intrathecal” space). The most commonly used intrathecal drug for spasticity is baclofen. Intrathecal baclofen can be used in conjunction with the other treatments listed above. This treatment is generally not recommended until other treatments have been tried and failed to provide relief or if oral medications cause unacceptable side effects.

Advantages of intrathecal baclofen:

- The drug is delivered directly around the spinal cord, so lower doses of medication are needed.
- Fewer negative side effects because the drug does not enter the bloodstream.
- The amount and dosing schedule of drug throughout the day can be precisely set and adjusted by the health care provider to meet each individual patient’s needs.
- The pump can be stopped or removed, if necessary.

Disadvantages of intrathecal baclofen:

- You will need surgery to implant the pump and catheter system. Any surgery has risks, such as infection.
- The pump has a limited battery life and will need to be replaced about every 5-7 years.
- You will need to go to your provider periodically for pump refills (done by injecting baclofen through the skin into the pump reservoir).

Mechanical problems with the device may occur and could result in a baclofen overdose or underdose. For this reason, it is important for you to understand the risks, monitor yourself carefully, and get regular follow-up from your provider.

### ▪ Other Surgery

Other surgical treatments for spasticity are far less commonly performed because they are not reversible. These include cutting a section of the spinal cord (myelotomy) or nerve roots (rhizotomy), or lengthening and transposing a tendon. Your doctor will discuss these surgical options with you if necessary.

## Which treatment is best for me?

Discuss your specific needs and treatment options with your health care provider or team. You may need to try different methods, medications, or combinations of treatments before you feel your spasticity is under control. Consider the following questions and discuss them with your provider:

- What are your goals for treatment of your spasticity?
- How important is it that the treatment can be reversed or stopped?
- What are the possible short-term and long-term side-effects of each treatment?
- Are there other health conditions that would influence the treatment choice?
- If you are considering intrathecal baclofen: Will you be able to follow the maintenance requirements? Do you have a good understanding of the possible risks and benefits?

Whatever treatment you choose, you will need to work closely with your treatment provider or team to get the best possible outcome.

## What happens to spasticity over time?

In general, spasticity appears to become less bothersome over time. Possibly this happens because people learn to avoid things that trigger spasticity. Changes that naturally go on in the body as you age, such as a slowing down of nerve conduction, may also decrease spasticity. However, an unexplained, sudden or dramatic change in your spasticity level may sometimes signal a problem, so let your health care provider know immediately.

### Source

Our health information content is based on research evidence whenever available and represents the consensus of expert opinion of the SCI Model System directors.

### Authorship

Spasticity and Spinal Cord Injury was developed by Maria R. Reyes, MD and Anthony Chiodo, MD, in collaboration with the University of Washington Model Systems Knowledge Translation Center.

Portions of this document were adapted from materials developed by the University of Michigan and UAB Model Systems.

### Disclaimer

This information is not meant to replace the advice from a medical professional. You should consult your health care provider regarding specific medical concerns or treatment.

# Spinal Cord Injury and Gait Training



For more information, contact your nearest SCI Model System. For a list of SCI Model Systems, visit <http://www.msktc.org/sci/model-system-center>

This publication was produced by the SCI Model Systems in collaboration with the University of Washington Model Systems Knowledge Translation Center with funding from the National Institute on Disability and Rehabilitation Research in the U.S. Department of Education, grant no. H133A060070.

Follow us!



Visit

<http://www.msktc.org/connect-with-us> to sign up.

Difficulty walking is very common following a spinal cord injury (SCI). People with an “incomplete” SCI have more potential to regain walking than those with a “complete” SCI, but people with both types of SCI may have gait training included in their therapy plans.

Gait training is practicing walking (also called ambulation) with assistive devices and braces as needed. The following categories are used by health professionals to describe the kind of walking you are able to do.

- **Community:** You are able to walk at home and in the community.
- **Household:** You can walk within the home and use a wheelchair as the primary way to get around in the community.
- **Exercise:** You use a wheelchair in the community and at home, and you walk with assistance once or twice a day for exercise.
- **Non-ambulatory:** You only use a wheelchair for mobility. You may also walk while doing gait training with the therapist in the therapy gym only.

## Why is gait training needed?

A spinal cord injury damages nerve cells and can prevent movement signals from the brain to the muscles. It can also disrupt the signals that do reach the muscles, making the muscles “jump” on their own. Therefore, a SCI can create weakness and spasticity in the feet, legs, hips, and trunk, as well as in the hands and arms. The injury can also damage and disrupt nerve signals for sensation (feeling) so that parts of the body are without sensation or have abnormal sensations, such as burning or tingling. Each of these problems can lead to difficulty walking.

## Is gait training right for you?

A physical therapist (PT) or other clinician will determine if gait training is right for you by using a variety of tests. He/she will test your strength, sensation, ability to stand up, balance while standing, spasticity or stiffness, and range of motion at your hips, knees, ankles, and trunk. If you are able to take some steps, the clinician will watch you walk to look for safety issues.

The clinician may also provide you assistive devices and/or braces to give you better balance, protect your joints, and ensure your safety as you walk. He/ she may then test your walking speed, endurance, and balance with these devices and braces to keep track of your therapy progress. Gait training can require a lot of work and be a long process, so it is important for your PT or other clinician to tell you what you can expect. Some people with SCI work

on balance and other “pre-gait” activities many times a week for over 6 months before they start actual gait training (involving walking). Gait training may not be appropriate early in your recovery, but it may be at a later point when you are stronger and have better balance.

## Gait training treatment options

### Early Gait Training

You may take your first steps after the SCI using a variety of equipment including parallel bars, a pool, or a body-weight support device. A body-weight support device lifts part of your weight through a harness you wear as you try to take some steps. Some of these devices roll on the ground and some are placed over a treadmill. Your therapist, a therapy team, or a robotic-device may help with your balance and stepping movements. It is very beneficial to be upright and moving as soon as your doctor says it is OK.

### Later Gait Training

Depending on your SCI, your therapist may begin to work with you on the ground without a body-weight support device or parallel bars. You may also be given assistive devices and/or braces to improve your balance and help you walk safely. A device may be more or less appropriate depending on your strength and balance. It is helpful to experiment with different assistive devices and braces to find what is right for you.

### Assistive devices may include:

- special walkers that have safety straps at your hips and trunk.
- a standard walker with no wheels on the legs.
- a rolling walker (walker with 2 wheels on front legs), if your balance is a little better.
- a rolling walker with forearm platforms, if you have weak arms.
- a rollator walker (walker with 4 wheels and a basket), if you have good enough balance to walk in the community.

- one or two forearm(or “Loftstrand”) crutches, if you have better strength and balance, but a weak grip.
- one or two quad canes with four tips at the bottom, if you have pretty good strength and balance and at least a fair grip.
- one or two straight canes with a single tip at the bottom, if you only need a little help with your balance and have a good grip.

If you are able to use crutches and canes, you will likely start with two, using one in each hand. Sometimes you will train with a crutch or cane in only one hand to be able to use your other hand to carry things, open doors, etc. However, you should be careful when using only one crutch or cane. Many people who use a device in only one hand tend to lean on it too much and develop a limp to that side. Using a device in each hand helps to keep your posture straight and your steps even.

## Braces

Braces can have many benefits such as the following:

- Protecting weak joints and preventing knee hyperextension by keeping your joints in the proper alignment as you put weight on them during walking.
- Reducing the risk of falling by helping to keep your knee straight and your toes up as you take a step.
- Increasing your walking speed and how long you are able to walk.

### Types of braces:

- ankle-foot-orthosis (AFO).
- knee-ankle-foot-orthosis (KAFO).
- hip-knee-ankle-foot-orthosis (HKAFO).
- floor reaction orthosis for people with knees that buckle.
- supra-malleolar orthosis (SMO) at just the ankle to keep you from “turning your ankle”.

Braces may be made of plastic and metal, just plastic, or carbon fiber. They may be “off-the-shelf” pre-made braces, or they may be custom made by an orthotist to fit you. Some newer ankle-foot-orthosis designs, such as the lateral strut braces, try to fit more people with a more versatile and open pre-made shape.

It is recommended that you get evaluated by your therapist or orthotist to determine the best brace for you, especially if you cannot feel where the brace will go.

Always be sure you check your skin before you put the brace on and after you take it off, looking for reddened areas on your skin or open wounds. If the brace has caused a pressure sore, do not wear it again until your therapist or orthotist can modify it for you.

### Body-weight support device

If you are eventually able to walk with assistive devices or braces, you may still continue gait training on a body-weight support device to help increase your speed and improve your balance and the timing, coordination, and symmetry of your steps. This is performed without using walking devices or braces. You will receive verbal instructions and manual assistance from your therapist and team. All levels of gait training activities can be practiced safely in the harness of these devices, because you cannot fall.

Transferring what you have practiced in the harness to the ground is very important. Assistive devices and braces may still be required to protect your joints and prevent you from falling while transferring to the ground.

Continued gait training with your therapist will hopefully improve your balance and strength so that you can rely less on devices or braces.

### Will gait training be effective for you?

The ultimate goal of gait training is to be able to walk in any community environment without assistive devices or braces, but many people will still need one or the other, or both.

Every individual makes progress in therapy at their own pace. Some people may learn to walk

well in a few months, and others may take years. Still others are unable to progress beyond just walking in therapy.

### Safety

If you experience falls while walking with or without assistive devices, be sure to tell your health professional as you may need different walking supports and/or more training. People with SCI can have fragile bones due to lack of physical movement, so falling can cause broken bones. Preventing falls is a top priority during gait training and walking in the community.

### Outcomes of Gait Training

The ability to walk after a spinal cord injury depends on many factors including your:

- level of injury
- severity of injury
- time since injury
- age
- level of fitness
- other injuries
- level of sensation
- other related problems such as spasticity and joint problems (contractures)
- level of pain

Therefore, it is difficult to predict if a person with SCI will regain walking abilities.

Looking at severity of injury as a factor, the following numbers show the percentage of people in a study who walked with some kind of assistive device and/or braces but no physical assistance from another person, at the time of discharge from inpatient rehabilitation. The ASIA Impairment Scale (AIS) classification level was made when patients were admitted to the hospital.

Proportion of people with SCI who walked at inpatient discharge with devices/braces and without physical assistance:

- ASIA A (motor and sensory complete): 6.4%
- ASIA B (motor complete, sensory incomplete): 23.5%
- ASIA C (motor and sensory incomplete, generally weaker legs): 51.4%
- ASIA D (motor and sensory incomplete, generally stronger legs): 88.9%

Those with the most severe, “complete” SCIs may experience that walking with their assistive devices and braces is very difficult and slow. They often decide to use a wheelchair to maneuver quickly and efficiently through their daily lives, and practice walking with devices and braces for exercise only. Regarding level of injury, those with a complete injury level below T11 have greater potential to walk in the community while using devices and braces.

People with incomplete SCIs have greater potential than those with complete SCIs to regain function and walking. Those with the “incomplete” injuries Brown-Séquard Syndrome (left or right half of the spinal cord is injured) or with Central Cord Syndrome (the arms are more affected than the legs) have the greatest potential to regain walking. People with SCI who have more accurate sensation also have a better chance of walking.

## Resources

Atrice MB, Morrison SA, McDowell SL, Ackerman PM, Foy TA. Traumatic spinal cord injury. In: Umphred DA. *Neurological Rehabilitation*. 5th ed. St. Louis, MO: Mosby; 2006: 605-657.

Field-Foté E. *Spinal Cord Injury Rehabilitation (Contemporary Perspectives in Rehabilitation)*. Philadelphia, PA: F A Davis Co; 2009.

Sisto SA, Druin E, Macht Sliwinski MM. *Spinal Cord Injuries: Management and Rehabilitation*. St. Louis, MO: Mosby; 2008.

M Selzer, B Dobkin. *Spinal Cord Injury: A Guide for Patients and Families (American Academy of Neurology)*. New York, NY: Demos Health; 2008.

## References

Gittler MS, McKinley WO, Stiens SA, Groah SL, Kirshblum SC. Spinal cord injury medicine. 3. Rehabilitation outcomes. *Arch Phys Med Rehabil*. 2002;83 Suppl 1: S65-71.

Morganti B, Scivoletto G, Ditunno P, Ditunno JF, Molinari M. Walking index for spinal cord injury (WISCI): criterion validation. *Spinal Cord*. 2005;43: 27-33.

Zörner B, Blanckenhorn WU, Dietz V, EM-SCI Study Group, Curt A. Clinical algorithm for improved predication of ambulation and patient stratification after incomplete spinal cord injury. *J Neurotrauma*. 2010;27:241-252.

Winchester P, Smith P, Foreman N, Mosby JM, Pacheco F, Querry R, Tansey K. A prediction model for determining over ground walking speed after locomotor training in persons with motor incomplete spinal cord injury. *J Spinal Cord Med*. 2009;32:63-71.

## Disclaimer

This information is not meant to replace the advice from a medical professional. You should consult your health care provider regarding specific medical concerns or treatment.

## Source

Our health information content is based on research evidence whenever available and represents the consensus of expert opinion of the SCI Model System directors.

## Authorship

SCI & Gait Training was developed by Leslie VanHiel, BME, MSPT, CCRC., in collaboration with the Model Systems Knowledge Translation Center.

# Getting the Right Wheelchair:

## What the SCI Consumer Needs to Know



For more information, contact your nearest SCI Model System. For a list of SCI Model Systems go to: <http://www.msctc.org/sci/model-system-centers>

This publication was produced by the SCI Model Systems in collaboration with the University of Washington Model Systems Knowledge Translation Center with funding from the National Institute on Disability and Rehabilitation Research in the U.S. Department of Education, grant no. H133A060070.

Your wheelchair is an important part of your life, so you want to make sure you end up with the right wheelchair that fits your body, preferences, activities and lifestyle.

Wheelchair seating technology is a complex and rapidly changing industry, with new types of wheelchairs and components coming on the market all the time. The days of “one size fits all” are long gone. With all the different choices, how do you pick the right one? Many different factors must be considered when making the decision.

### The Clinic

Selecting the right clinic is a critical first step. The clinic you select should have a process and the key players in place to assist you with making the right choice. You can call in advance to find out who is part of the team, if they have certification, and how long the process takes. It may be necessary for you to travel to get the best team to work with you on your chair. You would not hesitate to drive a long distance for the right surgeon; your wheelchair selection is equally important.

### The Team

The right clinic will have a team of individuals to help with wheelchair selection, each of whom has different expertise.

- **You:** The most important member of the team is you, the wheelchair user. Even if this is your first wheelchair, your opinions and desires are essential in order to make the best selection.
- **Family members or caregivers:** Individuals you live with or who care for you will also be affected by the wheelchair selection and should provide input.
- **Rehabilitation professionals:**
  - **Rehabilitation medicine doctor** (called a **physiatrist**) who understands your overall health situation. The doctor is the one who writes the prescription needed for your insurance to pay for the wheelchair and has ultimate responsibility for determination of medical necessity.
  - **Occupational or physical therapist** who is experienced in wheelchair evaluation and training.
  - **Qualified wheelchair supplier** who works with the therapy and medical team to trial, order and maintain equipment.
  - **Certification:** Many occupational and physical therapists and wheelchair suppliers will have Assistive Technology Practitioner (ATP) certification from RESNA (Rehabilitation Engineering and Assistive Technol-



ogy Society of North America) indicating they have passed a national examination and credentials check in their specialty. If Medicare is the payer, they require the wheelchair vendor to have at least one ATP-credentialed specialist.

## Medical and Physical Considerations

The team needs to consider many factors to ensure that you get the right wheelchair for your body, your health and your care needs.

- **Time since injury**
  - **Newly injured individuals:** If this is your first wheelchair, you will likely need more advice on the technology that will best suit your needs. In addition, you may continue to have physical changes or recovery over the next several months, in which case this first chair may only be temporary. As a result, the team may recommend a rental chair or more frequent follow-ups.
  - **Long-time injuries:** If you have been using a wheelchair for a long time and have developed new problems, such as weakness or pain, you may need to make changes to your current wheelchair seating system.
- **Age** affects endurance and strength and may be a deciding factor between a manual or power wheelchair.
- **Strength and range of motion** will determine whether or how much you can push your wheelchair, transfer in and out of your wheelchair, lift and fold your wheelchair, etc.
- **Height and weight** will affect what size wheelchair you will need.
- **Trunk stability:** The higher your level of injury, the more unstable you are likely to be, and this requires extra attention to seating and position to enhance stability.
- **Functional abilities:** Your level and completeness of spinal cord injury will affect how much function you have in your arms and hands and whether you will need a power or manual wheelchair.
- **Medical conditions or risks:** Conditions such as spasticity, previous pressure sores, or urinary

leakage can also affect wheelchair selection and should be discussed with your team.

## Caregiver Considerations

It is important for the people who care for you to be able to work with your wheelchair, which may include pushing it occasionally or lifting, folding, fixing, cleaning or adjusting the wheelchair.

## Environment and Lifestyle Considerations

Your wheelchair is a tool that enables you to do more of what you want in life.

- **Home:** Is your home carpeted? Are entrances to your home steep? Are there difficult surface conditions that a wheelchair might need to push over, such as gravel or grass? While you may make changes to your home to accommodate a chair, it is also possible that chairs exist that can help you when changes to the home environment are not possible or desired.
- **Work:** What will you be doing for work, and how does your wheelchair need to fit into that environment? For example, will your wheelchair fit under the conference room table where you meet twice a week?
- **Transportation:** Will you be driving your own vehicle? Van or car? Will you be taking public transportation? Will someone else be driving you around?
- **Leisure activities:** Will you spend time outdoors on grass or hiking on trails? Will the wheelchair also be used for sports?
- **Personal taste/preferences:** For example, some people may prefer a sportier-looking chair or a specific color (but note that something other than the standard color may cost more).

## Financial Considerations

- **Insurance coverage:** This is often a major consideration when choosing a wheelchair and may limit your choices. However, it is best to choose the optimal chair first, then consider your financing.
- **Other financial resources:** Local resources to assist in purchasing your chair may be available

through organizations such as United Cerebral Palsy or the Multiple Sclerosis Society. Despite their names, these organizations often help people with any disability. Some individuals have fund-raisers through their church or temple.

## Steps in the Process of Getting a Wheelchair

- 1. History and physical exam** by physician, OT, and/or PT, who will use this information to justify (to the insurance company) the wheelchair and seating system you need and to ensure that medical issues are properly addressed.
- 2. Test Drive:** You should always test drive the device. Ideally this will occur at the clinic during your visit and later during the home assessment. A good wheelchair clinic should have the ability to get devices for you to test drive during your visit.
- 3. Home assessment:** It is best to have a supplier or therapist assess your home to recommend appropriate equipment. Some insurance plans (including Medicare) require this step, and others do not.
- 4. Submission of prescription and documentation**  
The clinical team will likely need to submit a Letter of Medical Necessity (LMN).
- 5. Delivery, final fitting and wheelchair driving skills training:** Ideally the wheelchair will be delivered to the clinic, where the team will make sure that the wheelchair that was ordered is, in fact, what was delivered. In addition, the chair will likely need to be adjusted for the best fit. Finally, the team will train you on how to use the chair properly to avoid injury.

## Plan Ahead

It is important to plan for the possibility that your wheel chair will break down and need repairs. If possible, keep a spare wheelchair on hand. If not, have a plan in place to insure timely repair and the use of a loaner.

## Pressure Mapping Technology

Pressure mapping technology is a way of measuring seating pressure and can help a clinician decide which cushion provides the best pres-

sure distribution for a particular individual. A pressure-mapping evaluation of a cushion and seating system can help make sure your skin is protected.

## Resources

*Choosing A Wheelchair: A Guide for Optimal Independence* by Gary Karp (Cambridge, Mass: O'Reilly, 1998).

## Also in the SCI Model Systems Consumer Information Series on Wheelchairs:

- *The Manual Wheelchair: What the SCI Consumer Needs to Know*
- *The Power Wheelchair: What the SCI Consumer Needs to Know*

## Source

Our health information content is based on research evidence whenever available and represents the consensus of expert opinion of the SCI Model System directors.

## Authorship

*Getting the Right Wheelchair: What the SCI Consumer Needs to Know* was developed by Michael L. Boninger, MD, in collaboration with the University of Washington Model Systems Knowledge Translation Center.

## Disclaimer

This information is not meant to replace the advice from a medical professional. You should consult your health care provider regarding specific medical concerns or treatment.



**Spinal Cord Injury Model System**  
**SCIMS | NIDRR**  
A NIDRR Funded Program

# The Manual Wheelchair

## What the SCI Consumer Needs to Know



For more information, contact your nearest SCI Model System. For a list of SCI Model Systems go to:  
<http://www.msktc.org/sci/model-system-centers>

This publication was produced by the SCI Model Systems in collaboration with the University of Washington Model Systems Knowledge Translation Center with funding from the National Institute on Disability and Rehabilitation Research in the U.S. Department of Education, grant no. H133A060070.

### Introduction

The wheelchair is a complex piece of equipment that has been extensively engineered and studied. Most individuals with SCI become wheelchair experts because doing so increases their chances of getting a wheelchair that truly meets their needs. However, there are numerous options when considering a manual wheelchair, so it is critical to get help (see the SCI Model System Consumer Information guide *Getting the Right Wheelchair: What the SCI Consumer Needs to Know*). While it is not possible to teach you all there is to know in a single handout, this factsheet includes some of the most important information.

### Why Choose a Manual Wheelchair?

If you have enough function to propel a manual wheelchair, it is probably the best form of mobility. Manual wheelchairs are easy to transport, need fewer repairs, and provide a form of exercise. However, they are not for everyone; you need to have the ability to propel. Most people with an injury level below C6 can propel a manual chair and some individuals with a C6 level can as well; this will be dependent on your weight, fitness, strength, level of pain, and the environment in which you need to push. While manual wheelchair propulsion can be a form of exercise, it can also lead to arm injuries from repetitive use. This risk makes it critical to get the right chair, to set it up correctly and to learn how to effectively propel.

### Features and Components

#### Weight

Wheelchairs are generally classified by Medicare (which sets the industry standards) as *lightweight* (less than 34 lbs.) and *ultralight* (less than 30 lbs.). (These weights do not include footrests or armrests.)

Lightweight chairs are often not adjustable and are not recommended for SCI. Ultralight chairs are more expensive than the lightweight chairs, are highly adjustable, and incorporate many design features that improve mobility and comfort. Adjustability allows the wheelchair to be set up for optimal propulsion efficiency, which can reduce the risk of injury. It is harder to get insurance companies to pay for this type of wheelchair. Clinical practice guidelines recommend the lightest chair possible. Titanium and aluminum chairs can weigh under 20 lbs.

#### Frames

Frames may be folding or rigid. Rigid frames tend to perform better when maneuvering. Folding frames are often easier to transport, although many

rigid chairs can get to a very small size by removing the wheels and folding down the backrest.

## Components

Many components (Figure 1) are important for wheelchair function. These components come in a variety of styles, and selection depends on your needs, preferences and lifestyle.

- **Footrests** support your feet and lower legs. They can be fixed, folding or swing-away and come in many different styles.
- **Armrests** are places to rest your arms when you're not moving. They can be wraparound, full-length or desk-length; fixed or height-adjustable; removable or flip-back. Fit is important because armrest position can alter the way you propel your wheelchair. Many individuals choose not to have armrests because they don't like the way they look or they get in the way of propulsion.
- **Wheel locks** act as parking brakes to stabilize your wheelchair when you transfer to other seats or want to remain in a particular spot. They may be push-to-lock or pull-to-lock, positioned low or high on the wheelchair, and retractable or not, depending on what the user finds easier. Wheel locks can get in the way during propulsion and add weight to the wheelchair. For this reason many individuals choose not to have wheel locks, relying on their hands to keep their chair still. Not having wheel locks can increase the risk of the chair moving during a transfer, however, which you should consider when making this decision.
- **Tires** are most commonly air-filled (pneumatic) and therefore lightweight. They also require maintenance and can puncture. If you maintain them, this is usually the best choice. Pneumatic tires may instead be filled with solid foam inserts; these won't puncture but are slightly heavier and don't perform as well. Solid tires are low-cost and no-maintenance, but make for an uncomfortable ride and are not usually recommended.

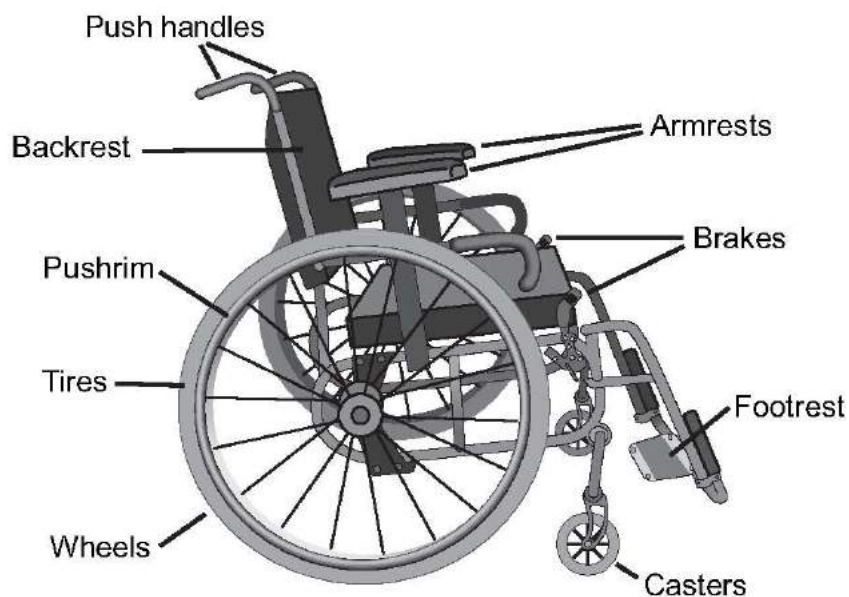

Figure 1. Wheelchair Components

- **Backrest:** Sling backrests are the most common, but provide little postural support. Adjustable tension backrests can provide more support and can be adjusted over time. Rigid backrests provide the best support, but may make it more difficult to collapse the chair. The weight and height of the backrest are important. In general, the lighter the better, with carbon fiber backrests being a nice option. If support is not needed, a lower backrest is better as it does not get in the way of pushing.
- **Cushions** come in a huge and ever-changing array of different types and materials and comprise a major topic unto itself. While pressure relief is an important consideration when selecting a cushion, you should also keep in mind that you want a firm base and a light-weight cushion. A firm base refers to feeling stable, not sliding on the cushion when reaching for an object or propelling your chair.
- **Pushrims:** There are a variety of pushrims with different friction coatings and shapes that may assist with propulsion and reduce the risk of injury to the hand.
- **Additional features** include anti-tippers, wheels and caster wheels of various styles, push handles and grade-aids (which keep the chair from rolling backward).

## Set-up and Fit

Set-up and fit of your wheelchair is critical to good performance.

- **Seat height and width:** If the fit is too tight, it can cause pressure sores; too wide, and it may cause problems with stability, posture and fitting through doorways. The seat height should make it easy to access the pushrim as well as transfer surfaces. To test this, let your hands dangle at your side when sitting in the chair: your fingertips should extend just past the chair's axle.
- **Seat slope** is the difference between the front seat-to-floor height and the rear seat-to-floor height. It is common to have a slight seat slope (so buttocks are lower than your knees) to keep your body stable in your wheelchair.
- **Rear axle position** is important as it impacts how easy it is to push and tip your chair. In general you want the rear axle as far forward as possible (this will make it easier to push) without making the chair too easy to tip over backwards.
- **Camber** is the angle of the wheel with respect to the chair (Figure 2). A little camber is a good thing as it will protect your hands and increase your base of support. Too much camber will make it hard to fit through doorways.

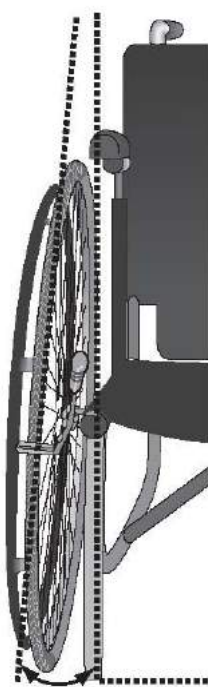

Figure 2.  
Camber

## Propulsion

Your therapist will train you on the best way to propel your wheelchair to be efficient and avoid injury. Long smooth strokes are better than short strokes, and the hand should drop below the push rim during the recovery (non-pushing) part of the stroke.

## The Wheelie

Ask your physician for a referral to a therapist who can teach you how to “pop” and hold a wheelie. This skill can help you get through uneven terrain and over curbs. It can give you

greater awareness of your balance point, which may decrease your chances of tipping over. When performing a wheelie, if your front wheels are more than two or three inches off the ground, your rear axle is probably too far back and could be adjusted forward.

## References

Boninger ML, Cooper RA, Fay B, Koontz A, *Musculoskeletal Pain and Overuse Injuries in Spinal Cord Medicine: Principles and Practices*, Demos Medical Publishing, NY, 2003.

## Resources

ABLEDATA is a non-commercial information center for assistive technology, including wheelchairs. Go to [www.abledata.com](http://www.abledata.com) (select *Products*, then *Wheeled Mobility*) or call 800-227-0216.

Consortium for Spinal Cord Medicine, *Preservation of Upper Limb Function Following Spinal Cord Injury: What You Should Know* (Paralyzed Veterans of America, 2005).

Gary Karp, *Choosing A Wheelchair: A Guide for Optimal Independence* (Cambridge, Mass: O'Reilly, 1998).

Cooper RA, Olson J, Cooper RM, *Manual Wheelchair Lingo*, *Paraplegia News*, pp. 17-24, Vol. 63, No. 11, November 2009.

## Also in the SCI Model Systems Consumer Information Series on Wheelchairs:

- *Getting the Right Wheelchair: What the SCI Consumer Needs to Know*
- *The Power Wheelchair: What the SCI Consumer Needs to Know*

## Source

Our health information content is based on research evidence whenever available and represents the consensus of expert opinion of the SCI Model System directors.

## Authorship

*The Power Wheelchair: What the SCI Consumer Needs to Know* was developed by Michael Boninger, MD, in collaboration with the University of Washington Model Systems Knowledge Translation Center.

## Disclaimer

This information is not meant to replace the advice from a medical professional. You should consult your health care provider regarding specific medical concerns or treatment.



**Spinal Cord Injury Model System**  
**SCIMS | NIDRR**  
A NIDRR Funded Program

# The Power Wheelchair

## What the SCI Consumer Needs to Know



For more information, contact your nearest SCI Model System. For a list of SCI Model Systems go to: <http://www.msktc.org/sci/model-system-centers>

This publication was produced by the SCI Model Systems in collaboration with the University of Washington Model Systems Knowledge Translation Center with funding from the National Institute on Disability and Rehabilitation Research in the U.S. Department of Education, grant no. H133A060070.

### Introduction

The wheelchair is a complex piece of equipment that has been extensively engineered and studied. Most individuals with SCI become wheelchair experts because doing so increases their chances of getting a wheelchair that truly meets their needs. However, power wheelchairs are technologically advanced and have many components, so it is critical to get help when purchasing a new chair (see the SCI Model Systems Consumer Information guide *Getting the Right Wheelchair: What the SCI Consumer Needs to Know*). While it is not possible to teach you all there is to know in a single handout, this factsheet includes some of the most important information.

### Why Choose a Power Wheelchair?

A power wheelchair is appropriate if you are unable to propel a manual wheelchair or if you need to reduce the strain on your shoulders and arms so you can continue to perform transfers safely. The choice of power chair will depend on many factors, including the kind of surface conditions the chair will be driven over, the need to negotiate thresholds and curbs, and clearance widths in your usual environment.

### Power Wheelchair Components

#### The Base

The power wheelchair base is the lower portion of a power wheelchair that houses the motors, batteries, drive wheels, casters and electronics to which a seating system is attached. It is classified according to drive wheel location relative to the system's center of gravity.

#### Rear-Wheel Drive

The drive wheels are behind the user's center of gravity, and the casters are in the front. It has predictable drive characteristics and stability but can be difficult to maneuver in tight places because of its larger turning radius.

Figure 1. Rear-wheel drive power wheelchair

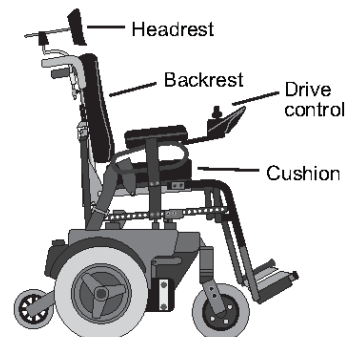

## Front-Wheel Drive

The drive wheels are in front of the user's center of gravity, and the rear wheels are casters. This setup tends to be quite stable and provides a tight turning radius. However, it may have a tendency to fishtail and be difficult to drive in a straight line, especially when traveling fast on uneven surfaces.



Figure 2. Front-wheel drive power wheelchair with recline capability.

## Midwheel Drive

The drive wheels are directly below the user's center of gravity. It has a smaller turning radius, making it more effective for indoor mobility, but not as good outdoors.

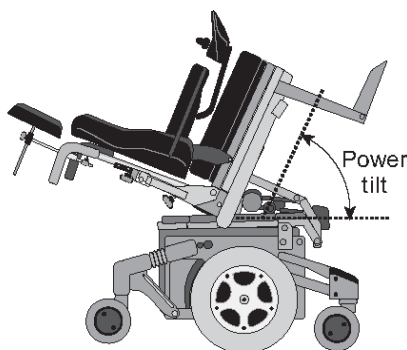

Figure 3. Midwheel drive power wheelchair with tilt-in-space capability.

## Controls

The device used to control a power wheelchair is called an *access device* or *drive control*. It can also be used with environmental control systems and computer access. These controls are usually programmable and can be operated using various kinds of joysticks or switches (such as sip-and-puff).

## Seating and Positioning

Seating and positioning are a critical part of your wheelchair and have an important role in your comfort, function, safety and health. Your seating system should be prescribed and designed specific to your medical, functional and personal preference needs, including protecting your skin from too much pressure.

### Seating Systems

Seating systems fall into three general categories: off-the-shelf, modular and custom. In general, custom seating is only needed when musculoskeletal deformities are present such as scoliosis, or after a flap surgery for a pressure sore. The basic components of the seating system are the cushion and backrest.

### Cushions and Backrests

Cushions and backrests are made out of a variety of materials, including contoured foam, air-filled bladders, combinations of air and foam, and gels. They vary in how well they address pressure distribution, postural stability, airflow, insulation or conduction of heat. Choice of style and material will depend on your individual needs and activities.

If all the needed features cannot be found in one cushion, trade-offs are necessary. Unlike with manual wheelchairs, the weight of the cushion and back support is generally not a consideration.

Research evidence suggests that a properly fitted pressure-reducing cushion, in contrast to a low-cost foam cushion, reduces the chances of getting a pressure sore.

## Recline and Tilt-in-Space

Recline and tilt-in-space technologies relieve pressure, manage posture, provide comfort and help with personal care activities.

Recline (Figure 2), which changes the angle between the seat and backrest, helps to stretch hip flexors and makes attending to catheters, toileting and transfers more convenient for caregivers.

The addition of tilt-in-space (Figure 3), which tilts the seat and backrest together, keeps the hip and

knee angles constant when tilting back. This reduces the possibility of shear when in the recline position.

People who cannot independently shift weight or transfer should have a tilt-in-space and recline system on their wheelchair.

## Seat Elevation & Standing Chairs

Power wheelchairs can also have elevating seats or mechanisms that stand the user upright while in the chair. Elevating seats can help with transfers, as it is easier to transfer downhill. In addition, elevating seats and standing chairs can make it easier and more functional to perform activities that are above shoulder height when sitting. Because performing activities above shoulder height puts you at risk of injuring your arms, recent guidelines recommend that all individuals with SCI who use power wheelchairs and have good arm function be provided with seat elevation.

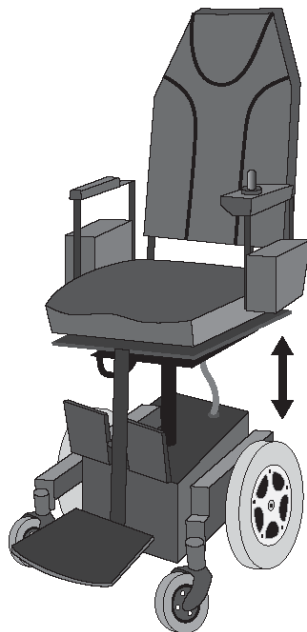

Figure 4. Power-elevating seat.

## Power-Assisted Wheelchairs

Power-assisted wheelchairs are essentially manual wheelchairs with a motor that provides propulsion assistance when desired. This allows a user to propel the wheelchair more quickly and easily, and helps with obstacles such as steep ramps.

For individuals with shoulder pain or tetraplegia (quadriplegia), this can be a good compromise between a manual and power wheelchair.

Power-assisted wheelchairs are bulkier and less maneuverable than manual chairs, but they are less bulky, easier to transport and more maneuverable than power wheelchairs.

## References

Boninger ML, Cooper RA, Fay B, Koontz A, *Musculoskeletal Pain and Overuse Injuries in Spinal Cord Medicine: Principles and Practices*, Demos Medical Publishing, NY, 2003.

## Resources

- ABLEDATA is a non-commercial information center for assistive technology, including wheelchairs. Go to [www.abledata.com](http://www.abledata.com) (select *Products*, then *Wheeled Mobility*) or call 800-227-0216.
- Consortium for Spinal Cord Medicine, *Preservation of Upper Limb Function Following Spinal Cord Injury: What You Should Know* (Paralyzed Veterans of America, 2005).
- *Choosing A Wheelchair: A Guide for Optimal Independence* by Gary Karp (Cambridge, Mass: O'Reilly, 1998).

## Also in the SCI Model Systems Consumer Information Series on Wheelchairs:

- *Getting the Right Wheelchair: What the SCI Consumer Needs to Know*
- *The Manual Wheelchair: What the SCI Consumer Needs to Know*

## Source

Our health information content is based on research evidence whenever available and represents the consensus of expert opinion of the SCI Model System directors.

## Authorship

*The Power Wheelchair: What the SCI Consumer Needs to Know* was developed by Michael Boninger, MD, in collaboration with the University of Washington Model Systems Knowledge Translation Center.

## Disclaimer

This information is not meant to replace the advice from a medical professional. You should consult your health care provider regarding specific medical concerns or treatment.





# **Volume 2: Factsheets Developed 2012–2017**

---



This fact sheet explains the important role that adaptive sports and recreation can play after a spinal cord injury (SCI). It also describes different types of sports equipment and points out some health problems to watch for as you participate in sports activities.

## Introduction

If you have an SCI, adaptive sports and recreation may be key to your lifelong wellness. These activities may also help you to engage with your community. Many options are available:

- ◆ Outdoor recreation activities (for example, adaptive kayaking, fishing, or snow skiing)
- ◆ Performing arts (for example, adaptive dance group)
- ◆ Individual sports (for example, wheelchair racing or hand cycling)
- ◆ Team or competitive sports (for example, wheelchair basketball, wheelchair tennis, quad rugby, or sled hockey)



Even if you have never taken part in sports before, you can find an adaptive activity that is right for you!

## Importance of Adaptive Sports and Recreation

An SCI does not have to keep you from being active. Adaptive sports and recreation are good for your health. Without such activity, you may be at higher risk for physical and mental health problems, such as obesity, heart disease, and depression. You may also feel left out if you do not engage in enjoyable activities. Others may assume that you cannot be active just because of your injury.

Adaptive sports and recreation can help you get past these challenges. People with SCI who are involved in adaptive sports and recreation in the community are more likely to

- ◆ maintain a positive mood and prevent depression;
- ◆ feel more included and empowered in their communities;
- ◆ connect with positive mentors and peers with SCI; and
- ◆ hold a steady job.



But most of all, adaptive sports and recreation give you a chance to do fun activities with your family and friends.

## How To Get Involved in Adaptive Sports and Recreation

You can get involved in adaptive sports and recreation! Here are some tips to make it easier:

1. Think about your goals for participating in adaptive sports and recreation. Goals will be different for everyone. Here are some examples:
  - ◆ To do something with your family and friends that everyone will enjoy
  - ◆ To make friends by joining a sports team
  - ◆ To become physically fit and improve your health
  - ◆ To live an active life and enjoy the outdoors
  - ◆ To experience the thrill of competing

The Spinal Cord Injury Model System is sponsored by the National Institute of Disability, Independent Living, and Rehabilitation Research, U.S. Department of Health and Human Services' Administration for Community Living. (See <http://www.msktc.org/sci/model-system-centers> for more information).

Keep your goals realistic and attainable. Ultimately, the goal of adaptive sports and recreation is to have fun and get out there!

2. Think about a location that is best for you to get involved in adaptive sports and recreation. You should consider your level of mobility, options for transportation, and how far you want to travel. Also think about whether you want to participate individually, on a team, or with family and friends.
3. Next, check out local resources. It may help to learn about all the options in your area so you can decide which one is best for you. Please see the section called “Adaptive Sports and Recreation Resources” for ideas.

Finally, try it out! Remember, it often takes time to learn a new skill. This may be true whether you are getting involved in adaptive sports and recreation for the first time or returning to sports after an SCI. If you don't like the activity you chose or don't feel successful at first, don't give up. You may find your activity more fun and fulfilling once you gain more skill and feel part of the adaptive sports community.



## Importance of Mentorship

Having a mentor may help you get started in a new activity, such as sports and recreation. Whatever sport you choose, there are likely other people with SCI who have tried and succeeded in that sport! A mentor can “show you the ropes” and help you to work on any challenges. If you can't find a mentor in your area, you could check out a magazine or blog that focuses on adaptive sports. The section below on “Adaptive Sports and Recreation Resources” lists some options.

## Types of Adaptive Sports Participation

You can choose from many types of adaptive sports and recreation. You may just be looking for fun, or you may want to compete. Here are some options to explore:

1. Community-based and nonprofit organizations may offer programs at no or low cost.
2. Every state has a parks and recreation association. Some focus on adaptive outdoor recreation. Examples include fishing, hunting, water skiing, or canoeing/kayaking.
3. Public schools must offer physical education and school-based sports to every student. Contact your local school district to find out about adaptive sports programs.
4. Many colleges and universities have adaptive sports programs. Examples include wheelchair basketball or track and field. Scholarships may be available to top athletes. Advocates are trying to get the National Collegiate Athletic Association (or NCAA) to sanction adaptive sports.
5. Paralympic sports highlight the skills of athletes with disabilities. People with SCI at all levels of function have the opportunity to compete.



## Adaptive Sports and Recreation Resources

Sometimes just knowing where to find the tools you need to succeed may help you get involved in adaptive sports and recreation. Here are a few tips.

### Organizations

1. Disabled Sports USA (DSUSA): DSUSA is a large membership organization with chapters across the United States. DSUSA leads a variety of adaptive sports programs for people with different types of disabilities, including SCI.  
<http://www.disabledsportsusa.org>
2. U.S. Paralympics Sports Clubs: Paralympics Sports Clubs offer entry-level competitive adaptive sports to athletes of all ability levels.  
<http://findaclub.usparalympics.org>
3. BlazeSports America: BlazeSports is based in Atlanta, GA, and provides adaptive sports and recreation programs regionally and internationally. Their goal is to make sure that youth and adults with disabilities have the same recreation opportunities as others.  
<http://www.blazesports.org>
4. Adaptive Sports, USA: ASUSA is also a membership organization focused on providing adaptive sports opportunities for youth with disabilities, including SCI.  
<http://www.adaptivesportsusa.org>
5. Rehabilitation Hospitals: Many rehabilitation hospitals support adaptive sports and recreation programs. Be sure to check out rehabilitation hospitals in your region or state to see if they have a sports program.



### Magazines and Web Sites

1. *Sports 'N Spokes*: This magazine covers recent and upcoming events in adaptive sports and recreation.  
<http://pvamag.com/sns/>
2. *Mpower Sports and Recreation*: This website highlights interesting stories about adaptive sports and recreation.  
<http://mpower-sports.com/category/home/>

### Equipment

Some local and national organizations, such as the ones listed here, help qualified applicants get sports equipment such as a sports wheelchair. It is important to try out and identify the equipment that works best for you before purchasing it.

1. Challenged Athletes Foundation: The Challenged Athletes Foundation provides grants for sports equipment to individuals with various types of disabilities. You can learn more at [www.challengedathletes.org](http://www.challengedathletes.org).
2. Kelly Brush Foundation: The Kelly Brush Foundation's goal is to break down the financial barrier to living an active lifestyle for individuals with SCI. You can learn more at <http://kellybrushfoundation.org>.

## How Do Competitive Adaptive Sports Work?

Adaptive sports and recreation are activities that anyone can do, regardless of their level of physical ability. This includes people with SCI. This section provides information regarding how competitive adaptive sports are organized.

## Types

In general, there are two types of adaptive sports:

1. Sports adapted to meet the needs of people with disabilities. For example:
  - a. Wheelchair basketball
    - ◆ Wheelchair basketball is played on a regulation basketball court using similar rules, with a few differences. For example, if a player pushes his/her sports wheelchair more than twice before dribbling, a “travel” foul is called.
  - b. Wheelchair tennis
    - ◆ Wheelchair tennis is played on a regulation tennis court using similar rules, with a few differences. For example, the “two-bounce rule” allows up to two bounces of the ball before a player must hit a return.
2. Sports created especially to be played by people with disabilities. For example:
  - a. Quad rugby
    - ◆ Quad rugby is a competitive team sport specifically designed for tetraplegic athletes.



As you can see, there are plenty of sport and recreation opportunities for people with SCI.

## Classification

In competitive sports, people with disabilities can be placed in “classes” that match their functioning ability. This system was set up so athletes only compete with other people in a similar class. This way, the competition is fair and the best athlete wins, not the athlete with the most physical function.

In team sports, athletes are assigned a class, or “point” value, based on their physical function. Players with higher physical function are assigned higher point values. A team is then made up of several athletes whose total points cannot exceed a certain threshold. This ensures that the team includes people of all ability levels.

More information on classification can be found here: [http://www.paralympic.org/sites/default/files/document/120716152047682\\_classificationguide\\_2.pdf](http://www.paralympic.org/sites/default/files/document/120716152047682_classificationguide_2.pdf)

## Sports Wheelchairs 101

Not everyone who has an SCI uses a wheelchair. For those who do, finding the right sports wheelchair can be tough, financially and otherwise. Almost every sport has its own type of chair. There are racing chairs, basketball chairs, tennis chairs, adaptive skis, and more. The two most common types of sports wheelchairs are rigid/custom fit or adjustable. If you know that you are going to be playing just one sport, you may want a custom chair. If you are new to a sport or plan to play multiple sports, an adjustable chair may be best.

Often, purchasing your own sports wheelchair is a step to take only after you become experienced in a sport. Many adaptive sports programs have chairs that you can borrow or rent simply to try it out. If you do decide to purchase a sports wheelchair, you will need to work with a manufacturer to select the chair that’s right for you. You should be fit for your chair by someone familiar with the sport you will be playing and the chair you want to purchase.

Here are a few examples (and there are many more):

**Racing Chair**



**Basketball Chair**



**Rugby Chair**



**Tennis Chair**



## Sports Injury Prevention

Overall, for most people the health benefits of sports participation outweigh the risks. That said, it is important to be aware of how to prevent sports injuries. Injury risk varies depending on what sport you are playing, however here are some things to keep in mind:

- For wheelchair users, the area most affected by injury is the upper extremity, particularly the shoulder. If you begin to experience shoulder pain or other symptoms while participating in adaptive sports, be sure to tell your therapist or physician.
- All people with SCI who are participating in sports should implement a basic shoulder injury prevention program. For more information on how this can be developed, a resource is "Life on Wheels" from the National Center on Health, Physical Activity and Disability (NCHPAD): <http://www.nchpad.org/1200/5830/Life~on~Wheels>.
- For more information on injury prevention, please see the section on "Overuse injuries" in the factsheet titled [Exercise After SCI](http://www.msktc.org/sci/factsheets/Exercise_after_SCI) ([http://www.msktc.org/sci/factsheets/Exercise\\_after\\_SCI](http://www.msktc.org/sci/factsheets/Exercise_after_SCI)).

## Be Aware of Other Potential Health Problems

Adaptive sports and recreation should be fun and safe. But problems and injuries can occur, for example:

- ◆ Skin breakdown
- ◆ Difficulties with regulating body temperature
- ◆ Orthostatic hypotension
- ◆ Autonomic dysreflexia
- ◆ Broken bones

For information on these problems and how to prevent them, see the factsheet titled [Exercise After SCI](http://www.msktc.org/sci/factsheets/Exercise_after_SCI) ([http://www.msktc.org/sci/factsheets/Exercise\\_after\\_SCI](http://www.msktc.org/sci/factsheets/Exercise_after_SCI)).

## Authorship

Adaptive Sports and Recreation was developed by Cheri Blauwet, M.D., and Jayne Donovan, M.D., in collaboration with the National Center on Health, Physical Activity and Disability (NCHPAD) and the Model Systems Knowledge Translation Center. Credit for these images goes to Lakeshore Foundation and NCHPAD.

**Source:** Content is based on research and/or professional consensus. Editorial experts from the Spinal Cord Injury Model Systems reviewed and approved this content.

**Disclaimer:** The content of this factsheet does not replace the advice of a medical professional. You should consult a health care provider about specific medical concerns or treatment. This fact sheet was developed under a grant from the National Institute on Disability, Independent Living, and Rehabilitation Research (NIDILRR grant number 90DP0082). This content may not represent the policy of the U.S. Department of Health and Human Services. The federal government may not endorse this content.

**Copyright © 2016** Model Systems Knowledge Translation Center (MSKTC). You can freely reproduce and distribute this content. Include proper attribution. But you must get permission before using this content in fee-based products.





It is important that rehabilitation is your main focus in the early weeks and months after injury. You can learn more about expectations for recovery, your role in rehabilitation, and find other suggestions to guide your recovery in “Understanding Spinal Cord Injury: Part 2— Recovery and Rehabilitation” at [www.msctc.org/sci/factsheets/Understanding\\_SCI](http://www.msctc.org/sci/factsheets/Understanding_SCI)

## What is adjustment?

Everyone experiences changes in their life. Adjustment is how you adapt to, or become used to those new situations. A few examples of exciting changes in life are starting a new job, getting married, and having children. Losing a job, getting divorced, and losing a loved one are examples of changes that can be challenging.

Having a spinal cord injury (SCI) is without doubt a new and challenging situation. SCI affects almost every aspect of your life when it happens, and it can be hard to put your life back in order and adjust to living with SCI. This initial adjustment period may be hard, but most people adjust well in time. Then, they continue to adjust to ongoing changes in life similar to those that everyone experiences.

## What is it like when you first go home after injury?

Going home is a major step in adjusting to life after SCI. It can be exciting to get back to the comforts of home. It can also be scary if you are unsure of what to expect once you get there.

Like most life-changing events, it takes time to adjust to a new “normal” after injury. For example, you were probably used to a daily routine before your injury. You may have gotten up each morning to go to school or work, taken care of your children, or had regular household chores. Whatever the routine was, the day seemed normal because you had some idea of what to expect.

After injury, you will establish a new “normal” routine. People who are newly injured often say it feels like they are doing things for the first time as they learn how to do activities differently. That feeling usually fades as you work through problems and learn how best to manage your daily routine.

- Chances are you will have outpatient rehabilitation for a while after inpatient rehabilitation. Your strength and stamina usually improves. Your ability to do daily activities usually improves. The time you spend out of bed and up in your wheelchair usually increases. At first, you may depend on medical equipment, such as a hospital bed or assistive devices, but not need them later.
- You usually learn to manage some of your activities during inpatient rehabilitation. However, you may change the way you manage things at home. For example, you may have showered or have done your bowel program at night during rehabilitation. You might find that doing these activities in the morning better fits your daily routine.

## How people adjust to SCI

People have different expectations for life after injury. It may be feeling happy. It may be doing meaningful and enjoyable activities. It may be preventing stress, depression, or anxiety. It may be any or all of these things or something else, but most people adjust by setting and meeting their own expectations for life after injury.

- Your personality and the way that you adjust to changes in your life do not usually change after injury. Therefore, you will adjust to life after SCI in your own way and in your own timeframe.
- You may feel “different” in your body in the early weeks and months after injury. This feeling usually fades as you become comfortable with your self-image, learn to manage self-care, gain a better understanding of your body, and come to realize you are still the same person.
- You may re-think some of your personal values and what you think of as most important in your life after injury. For example, you may focus your attention more on your relationships with family and friends than you did before your injury.

The Model Systems Knowledge Translation Center provides useful health information that is based on research evidence and/or professional consensus and has been reviewed and approved by the SCI Model Systems editorial team of experts. Additional fact sheets and information are at [www.msctc.org/sci](http://www.msctc.org/sci)



## Adjusting Well

There is no “one way” to adjust to life after SCI. However, research can offer some insight into what adjusting well looks like. People who adjust well:

- Do not experience depression, or if they are depressed soon after injury, they feel better again within a few weeks.
- Have an effective coping strategy.
  - Have a “fighting spirit” and use every means necessary to overcome challenges and setbacks.
  - View their injury as a challenge and see the potential for personal growth to make their life better.
  - Accept that their injury has happened and decide to live with it.
- Are resilient, meaning they bounce back when they experience difficult times or changes in life. You can make use of some common traits that people who are resilient have.
  - Seek purpose and meaning. Think about what you want in life. Is it a job? Family? You can have a job, a family and most anything else that you want in life. The key is to set the goals you want to achieve and relentlessly strive to reach those goals.
  - Stay connected with your support network. Your family, friends, faith, and others in your community can be a great resource to help you adjust to life after injury and reach your goals.
  - Use resources to make your life better. There are many organizations, agencies and community resources that offer help to people with SCI. Here are a few.
    - Job Accommodation Network ([www.askjan.org](http://www.askjan.org)) is the leading source of free, expert, and confidential guidance on workplace accommodations and disability employment issues. The Network website also has a list of State Vocational Rehabilitation Agencies that can help you return to work.
    - Independent Living Research Utilization ([www.ilru.org](http://www.ilru.org)) has a list of Centers for Independent Living and Statewide Independent Living Councils throughout the United States. These Centers are in every State. Your local Center can provide you with information and direct you to local resources. You can work one-on-one with an independent living skills trainer. You can get connected with others in your community if you need support and tips from a role model who is living independently. Your local Center can also help with accessibility and equal access to community services as well as transition from nursing homes to community-based living.
    - [www.Disability.gov](http://www.Disability.gov) is the federal government website for information on disability programs and services in communities nationwide. Search “spinal cord injury.”
  - Stay flexible. When you set goals, you may not reach them exactly as planned. Setbacks are common, but you can adjust your efforts to reach your goals.
  - Solve problems. You cannot avoid problems, and people with SCI who have good problem solving skills tend to have a higher quality of life and fewer medical complications. Here’s how you might approach solving problems:
    - Figure out what the problem or challenge is. Break big issues down into smaller, more manageable parts if needed and tackle one problem at a time.
    - Brainstorm— Think about all possible solutions and get input from family and friends. If another person is involved in the problem, make sure that person helps to brainstorm for solutions.
    - Choose the solution you think will work best. Make sure the solution is acceptable for everyone involved.
    - Try your solution to learn if it works.
    - Evaluate results— You have solved your problem if your solution works. If not, brainstorm, choose another solution and try it. Most solutions do not work perfectly the first time. Trying again and adjusting plans are keys to success.

## Difficulty with adjustment

It is normal to have days when you feel down or bad after SCI. However, people who have continuing depression tend to have difficulty adjusting after SCI. Sometimes depression happens soon after injury. In a few cases, depression begins some time later.

- People who become depressed usually fall into thinking and behavior traps. Talking with peers, professionals, family or friends may help you see these traps and find solutions. Here are some examples of thinking and behavior traps.
  - Believe they have no control over their life, rather than focusing on what they can control.



- Depend on others more than they need to, rather than seeking ways to become more independent.
- Focus on the bad thing that might happen, rather than on the good things that “could” happen.
- Give up trying to deal with difficulties caused by SCI rather than working out these difficulties over time.
- Focus on what they cannot do rather than on the meaningful or enjoyable activities that they are still able to do.
- More than 25% of people with SCI had difficulties with depression *before* they were injured. Being prone to depression, anxiety or other mental health problems can make it harder to adjust to SCI. If you are in this situation, it may serve you well to have regular mental health services during and after rehabilitation.
- Pain is a common risk factor for depression. Learn more about the types of pain and treatment options by reading “Pain after Spinal Cord Injury” at [www.msktc.org/sci/factsheets/pain](http://www.msktc.org/sci/factsheets/pain). However, not all people who have pain after injury become depressed.
- Talk to a professional if you think you might be depressed. Depression is treatable with medication and counseling. Learn more about depression and treatment options by reading “Depression and Spinal Cord Injury” at [www.msktc.org/sci/factsheets/Depression](http://www.msktc.org/sci/factsheets/Depression).

## Does family life change after injury?

### Relationships

Changes in family roles and relationships can be stressful for couples after SCI. It can take time for couples to find a new “normal” in their relationships. However, couples can work together to adjust over time and have a healthy relationship.

- Read “Sexuality and Sexual Functioning after Spinal Cord Injury” to learn more about managing relationships, sex, and having children after SCI at <http://www.msktc.org/sci/factsheets/sexuality>.

### Parenting

For any parent, raising a child is both challenging and rewarding. It is an ongoing learning process to determine what approaches are and are not effective for each child.

The fact that you have limited mobility does not mean you are less able to parent. Parenting is much more about supporting your child with love, devotion, and guidance rather than what you can do physically.

- Be fully involved in making decisions about your children’s day-to-day activities, including discipline.
- Children are naturally curious and will likely ask many questions about your injury. They usually adjust quickly when their questions are answered in terms they can understand.
- Unless you have a preexisting condition, having SCI does not prevent you from having children. In fact, people with all levels of SCI have children after injury. You can too if you choose.

## How can I be independent if I have to rely on others for help?

During rehabilitation, you learn how to do as much as you can on your own. While these skills help to lessen your reliance on help from others, you may need to ask for help to do the things that you cannot do. If asking for help is sometimes difficult to accept, here are two questions to consider.

1. How do you view independence? It is common to think of independence as being able to do everything on your own. However, most people depend on others, and you can probably think of many examples when you relied on others before your injury. You may have depended on a mechanic for car repairs or a friend or relative for picking the kids up from school. After SCI, it is helpful to think of independence as actually being in control of your life. Being in control means making decisions for yourself, learning how to best care for yourself and direct your personal care, and being an active voice in the decisions that affect you and your family.
2. Do you feel like you are a “burden” on those who help you? It is common to feel like a burden to a spouse or caregiver who does the physical tasks that you may no longer be able to do. You may hesitate to ask for help or speak up for something you want or need. However, you can help limit their stress by making decisions together. Open communication is one of the best ways to solve problems and reduce stress for everyone.

## What adjustments do I need to make to manage my health?

All aspects of your health and wellness are important. If you stay healthy, you are more likely to stay active, reach your life goals, and maintain a high quality of life. Although people who help with your care need to know about your medical needs, you are responsible for managing your health and directing your care.



- Learn about your risks for secondary medical conditions, how to prevent them from occurring, and what to do if you have a medical problem.
- It is important to have a healthy diet and stay active. Think about the activities you enjoyed before your injury. Those same activities can still be enjoyable even though you may need to make adjustments in the way you do them. You can also find new ways to stay active.
  - The National Center on Health, Physical Activity and Disability ([www.nchpad.org](http://www.nchpad.org)) is a great resource for lifestyle information.
- Schedule annual follow-up visits with your SCI-specialist and your Primary Care Provider.
  - Your SCI-specialist is well trained to manage the unique medical issues of SCI but does not usually provide primary care services.
  - Your Primary Care Provider is not trained in SCI issues but is trained to provide the healthcare services that everyone needs, such as treatment of common sicknesses and preventive medicine. They watch for early signs of medical problems and refer patients for specialized care when needed.

## Who can I talk to if I have problems or questions?

It is common to have problems with no easy solutions or questions with no easy answers. If so, you are not beyond help and do not have to be on your own.

You can seek input from multiple sources to help you with important issues. Family, friends, spiritual advisors, mental health professionals and people with SCI can be very helpful and supportive. There are a lot of good resources on the internet. However, be mindful that some websites and social media contain incorrect information.

Few people are well informed enough about SCI to provide the best advice, so your best sources for advice and information are usually professionals who are experienced with SCI issues.

- A physical or occupational therapist can help with activities of daily living.
- A doctor or nurse who is an SCI-specialist can help with medical needs.
- A counselor, psychologist, or social worker can help with concerns about mood, anxiety, relationships, substance use and getting back into enjoyable and meaningful activities. They can help with couples and family issues, too.
- When searching the internet for information, start your search by going to websites managed by a Spinal Cord Injury Model System. You can find a directory of SCI Model Systems at <http://www.msctc.org/sci/model-system-centers>
- If you are searching for peer support, you might start with two of the most reputable online support websites.
  1. [www.spinalcord.org](http://www.spinalcord.org) provides information and resources to meet the needs of people with SCI and their families and friends.
  2. [www.facingdisability.com](http://www.facingdisability.com) provides Internet-based information and support for people with SCI and their families. The website has more than 1,000 videos of family members answering real-life questions about how they cope with SCI.

## Authorship

Adjusting to Life after Spinal Cord Injury was developed by Phil Klebine, M.A., Charles Bombardier, Ph.D., and Elizabeth Richardson, Ph.D. in collaboration with the SCI Model Systems Knowledge Translation Center.

## References

Bonanno GA, Kennedy P, Galatzer-Levy IR, Lude P, Elfström ML. Trajectories of resilience, depression, and anxiety following spinal cord injury. *Rehabil Psychol*. 2012 Aug;57(3):236-47. doi: 10.1037/a0029256. PubMed PMID: 22946611.

Bombardier CH, Adams LM, Fann JR, Hoffman JM. Depression trajectories during the first year after spinal cord injury. *Arch Phys Med Rehabil*. 2015 Oct 22. pii: S0003-9993(15)01328-3. doi: 10.1016

**Disclaimer:** This information is not meant to replace the advice of a medical professional. You should consult your health care provider regarding specific medical concerns or treatment. The contents of this fact sheet were developed under a grant from the National Institute on Disability, Independent Living, and Rehabilitation Research (NIDILRR grant number 90DP0012). NIDILRR is a Center within the Administration for Community Living (ACL), Department of Health and Human Services (HHS). The contents of this fact sheet do not necessarily represent the policy of NIDILRR, ACL, HHS, and you should not assume endorsement by the Federal Government.

**Copyright** © 2016 Model Systems Knowledge Translation Center (MSKTC). May be reproduced and distributed freely with appropriate attribution.





Autonomic dysreflexia (AD) is a medical condition that can lead to serious stroke, seizure, organ damage, permanent brain injury, or even death if not treated immediately. This fact sheet will help you better understand AD and prepare you for what to do if you get it.

## What is Autonomic Dysreflexia?

Autonomic Dysreflexia (AD), sometimes referred to as Autonomic Hyperreflexia, is a potentially life-threatening medical condition that many people with spinal cord injury (SCI) experience when there is a pain or discomfort below their level of injury, even if the pain or discomfort cannot be felt.

## Am I at risk for AD?

- People with injury levels at or above T6 are at risk for AD.
  - Read Understanding Spinal Cord Injury Part 1 to learn about levels of injury at [www.msktc.org/lib/docs/Factsheets/SCI\\_Understand\\_Spin\\_Crd\\_Inj\\_Prt1.pdf](http://www.msktc.org/lib/docs/Factsheets/SCI_Understand_Spin_Crd_Inj_Prt1.pdf).
- People with injury levels below T6 may also be at risk for AD in some rare situations.

## Why do people with SCI get AD?

AD happens because there is a change in the body's autonomic reflexes after injury.

### Autonomic Reflexes before SCI

The autonomic nervous system controls body functions like blood pressure, heart rate, body temperature, sweating, digestion, sexual function, and dilation of your eyes' pupils through signals sent back and forth from the brain and body through the spinal cord nerves. These functions are largely automatic or involuntary, meaning they are controlled without you thinking about it.

There are two main systems within the autonomic nervous system.

- Sympathetic nervous system – this is the body's involuntary "fight or flight" response to prepare the body for action when there is some type of stress or threat. Pupils are dilated; the heart rate increases; the heart pumps with more force; and blood vessels get narrower causing blood pressure to rise.
- Parasympathetic nervous system – this is the "rest and digest" response. It causes digestion to improve, the heart to pump more slowly and with less force, and blood vessels get wider causing blood pressure to lower.

The body's first reaction to pain or discomfort is to go into the sympathetic, "fight or flight" mode. However, the brain usually reacts quickly and sends a parasympathetic, "rest and digest" response to counteract the sympathetic response. This normally creates the balance needed to prevent the body from overreacting to any pain or discomfort and staying in that "fight or flight" mode.

### Autonomic Reflexes after SCI

Your body's first reaction to pain or discomfort below your injury level is still to go into the sympathetic, "fight or flight" mode. Your brain then tries to send the parasympathetic, "rest and digest" response to counteract the sympathetic response, but your SCI blocks the signals from reaching the spinal cord below your injury level. The "rest and digest" response only reaches those areas above your injury level, and this allows the "fight or flight" mode to continue out of control below your injury level.

## Why is AD life-threatening?

AD is life-threatening because blood pressure can rise to dangerous levels when your body stays in that "fight or flight" mode.

The Spinal Cord Injury Model System is sponsored by the National Institute of Disability, Independent Living, and Rehabilitation Research, U.S. Department of Health and Human Services' Administration for Community Living. (See <http://www.msktc.org/sci/model-system-centers> for more information).

## Blood Pressure before SCI

The heart pumps blood to all parts of the body via blood vessels called arteries. Blood pressure is the force of the blood as it pushes against the walls of the arteries.

Blood pressure is always given as two numbers.

- Systolic (top number) is the pressure in the arteries when the heart squeezes to pump blood.
- Diastolic (bottom number) is the pressure in the arteries when the heart relaxes.

Most people have a normal baseline blood pressure of about  $\frac{120\text{mmHg}}{80\text{mmHg}}$ . Blood pressure changes depending on what a person is doing. For example, blood pressure can be higher during exercise or when a person is in pain. Blood pressure can be lower during rest or sleep. The brain monitors these changes and uses the autonomic nervous system to keep blood pressure in balance.

## Blood Pressure after SCI

Blood vessels around the bowels, which represent a large portion of the circulatory system that influences overall blood pressure, are controlled by nerve signals below T6. This is why people with injuries at T6 or above have difficulty keeping blood pressure in proper balance.

- Baseline blood pressure may be lower for some people with SCI, somewhere around the  $\frac{90-110\text{mmHg}}{50-60\text{mmHg}}$  range.
- AD occurs when a pain or discomfort somewhere below the T6 level of injury causes your systolic blood pressure to rise 20mm to 40mm higher than your normal baseline or your diastolic blood pressure to rise 15mm to 20mm higher than your normal baseline.
- Your blood pressure will continue to be high until the cause of the pain or discomfort is resolved. If not, the rise in blood pressure can lead to uncontrolled high blood pressure emergencies (hypertensive emergencies).
  - Hemorrhagic stroke (a rupture or leak in a blood vessel in the brain)
  - Organ damage (heart attack, heart failure, kidney failure)
  - Seizures (changes in the brain's electrical activity)
  - Death

## What can trigger AD?

AD can be triggered by anything that might normally cause pain or discomfort below your level of injury even if you cannot feel the pain. Here are the most common areas of concern.

- Bladder (#1 cause of AD) – the bladder is full and needs to be emptied. People who use indwelling (Foley) catheters, condom catheters (sometimes referred to as sheaths) or suprapubic catheter usually have a kink/blockage of urine flow causing the AD.
- Bowel – constipation, flatus (gas), bowel needs emptying, or hemorrhoids are inflamed.
- Skin – there is a pressure ulcer, pinched skin, cut, ingrown toenail, something too hot or cold touching the skin, or another problem.
- Broken bone
- Sexual activity
- Menstruation (women)

## What are the symptoms of AD and how do I know if I am having it?

The symptoms of AD are caused by the rising blood pressure. Symptoms vary from person to person, and there are some reports of no symptoms but high blood pressure during urination, bowel programs, bladder studies (urodynamics), and sperm retrieval. However, people usually experience one or more symptoms that are fairly easy to recognize.

- Pounding headache
- Slow pulse (although rare, a fast pulse can occur)
- Skin redness or flushing
- Chills without fever
- Restlessness
- Sweating above the level of injury
- Goose bumps
- Nasal congestion
- Blurred vision
- Cold and clammy skin below the level of injury

## What do I do if I have AD?

Most people with a T6 level of injury or above experience AD after injury. They also learn to recognize symptoms and know it is important to quickly act to find the source of the problem and fix it. Here is a checklist you can follow to resolve AD whenever you are experiencing it. Get help from a caregiver if needed.

- ✓ Check your blood pressure. Everyone at risk for AD needs to have a home blood pressure monitor and know how to use it.
  - Check your blood pressure about every five minutes while you try to find the cause of the AD episode.
  - If your systolic blood pressure is greater than 150 mmHg, then consider using some medication to lower it. Nitropaste applied to the skin above the level of injury is most commonly recommended. Wipe off the nitropaste once blood pressure is stable. Caregivers should wear gloves when applying the medication.
- ✓ Find the cause of AD and fix the problem if you can.
  - Sit upright.
  - Loosen any tight clothing or anything else that might be tight fitting.
  - Check to see if bladder is too full.
    - Is your catheter tube kinked or a condom catheter on too tight?
    - Does your bladder need emptying?
  - Check to see if your bowel is full.
    - If you have lidocaine gel, you can use it to numb the anal area before you check your bowel. This can help prevent causing more discomfort as you are checking.
  - Check skin for a pressure sore, inflamed hemorrhoids, cuts, burns, ingrown toenails, or any other skin irritation.
  - Check for broken bones.
- ✓ If you are unable to identify the cause of AD and/or control your blood pressure with the medications that you have, then you will need to seek medical attention. Call 911.
  - Clip the card (at the end of the factsheet) to carry with you. Give it to medical professionals to assist them in treating AD.

## Is there treatment for AD?

It is important to know what your baseline blood pressure usually is because it will help you know when you have AD and need to take action. AD will resolve if you follow the steps above to find the source of the problem and fix it. However, AD can occur without any obvious or easily treated cause and you may need to be hospitalized to manage your blood pressure while doctors search for the cause of the AD. Once you have identified the cause of an AD episode, you might need to make some changes in the way you do things to prevent future episodes.

## Can I prevent AD?

Good ongoing personal care is the best way to prevent AD.

- Maintain a consistent bladder program and take necessary steps to prevent infections.
- Maintain a consistent bowel program.
- Check your skin daily for pressure ulcers, and do regular pressure reliefs (also called weight shifting, pressure redistribution and pressure reduction) to prevent pressure ulcers.
- Avoid other skin injuries such as cuts, bruises and sunburn.
- Make sure you wear loose clothing and avoid clothes and shoes that are too tight.
- Use good techniques and well-functioning equipment to minimize the risk of falls and injuries.

Keep this wallet card with you at all times. Give it to medical professionals to assist them in treating AD.

Fold along solid Line

Cut along dotted Line

<b>MEDICAL ALERT</b>	<b>AD Examination Tree</b>
<p><b>Autonomic Dysreflexia (AD)</b> is a potentially life-threatening condition that occurs in persons with spinal cord injury (SCI) at the T6 level and above, even in the absence of sensation. In rare circumstances, AD can occur in persons with levels of SCI below T6.</p> <p><b>Cause:</b> AD is a reaction to noxious stimuli to intact sensory nerves below the SCI level leading to relatively unopposed sympathetic outflow and elevated blood pressure (BP). Parasympathetic outflow through cranial nerve X (vagus) can cause reflexive bradycardia but cannot compensate for severe vasoconstriction. Seizures, stroke, or death may occur if stimuli are not removed.</p> <p><b>Symptoms:</b> Hypertension, Chills without Fever, Pounding Headache, Bradycardia, Sweating above Injury Level, Nasal Congestion, Blurred Vision, Skin Flushing above Injury Level, Goose Bumps above Injury Level, Bronchospasms, Apprehension or Anxiety, and Seizures</p> <p><b>Treatment:</b> Sit patient up. Take BP and retake after each step of AD examination tree (reverse side). Normal systolic BP for persons with T6 SCI and above can be in the 90-110mmHg range. If BP is elevated &gt;150mmHg, use antihypertensive (consider nitropaste if no contraindications) with rapid onset and short duration while following the treatment steps to investigate the source of AD below injury level.</p>	<p>Follow steps below to identify noxious stimuli below the injury level. If possible, add local anesthesia to noxious stimuli prior to removal to prevent exacerbation. BP drop occurs with stimuli relief.</p> <ol style="list-style-type: none"><li>1. <b>Check Bladder for Distention:</b> Catheterize bladder using 2% lidocaine gel. If indwelling catheter already in place, inspect for kinks or obstructions. Irrigate or replace the catheter to insure patency.</li><li>2. <b>Check Bowel:</b> Anesthetize lower bowel using lidocaine gel 2% (wait 5 minutes) prior to checking for impaction.</li><li>3. <b>Check Skin:</b> Remove constricting clothing. Examine for pressure ulcers, insect bites, burns, abrasions, cuts, etc.</li><li>4. <b>Men:</b> Remove condom catheter if too tight. Genitalia pinched? Reflexogenic erection?</li><li>5. <b>Female:</b> Menstrual cramping? Intrauterine devices? Vaginitis?</li><li>6. <b>Miscellaneous:</b> Fractures? Urinary tract stones or infection? Ingrown toenail? Venous thromboembolism? Pneumonia? Retroperitoneal, intramuscular, intravesical hematoma? Spine or joint pathology?</li></ol> <p>Monitor AD symptoms and BP for at least 2 hrs after drop in BP with relief from stimuli. Admit patient if unresponsive to treatment or stimuli cannot be found.</p>

## Authorship

"Autonomic Dysreflexia" was developed by Anthony Chiodo, M.D., Deborah A. Crane, M.D., Maria R. Reyes M.D., Shawn Song, M.D. and Phil Klebine, M.A., in collaboration with the SCI Model Systems Knowledge Translation Center.

**Disclaimer:** This information is not meant to replace the advice of a medical professional. You should consult your health care provider regarding specific medical concerns or treatment. The contents of this fact sheet were developed under a grant from the National Institute on Disability, Independent Living, and Rehabilitation Research (NIDILRR grant 90DP0012-01-00). NIDILRR is a Center within the Administration for Community Living (ACL), Department of Health and Human Services (HHS). The contents of this fact sheet do not necessarily represent the policy of NIDILRR, ACL, HHS, and you should not assume endorsement by the Federal Government.

**Copyright** © 2015 Model Systems Knowledge Translation Center (MSKTC). May be reproduced and distributed freely with appropriate attribution. Prior Permission must be obtained for inclusion in fee-based materials.



***This fact sheet tells you about some of the more common methods to manage your bladder if it is not working correctly following your spinal cord injury***

## What you need to know

- Your spinal cord injury (SCI) might limit your ability to control your urine. You might not be able to stop urine from flowing, or you might not be able to release it.
- Uncontrolled urination or inability to empty your bladder can have a negative effect on your quality of life and cause bladder and kidney infections and other problems.
- Appropriate bladder management can help keep your bladder and kidneys healthy.
- Each type of bladder management option has pros and cons.
- Your doctor can help you choose the bladder management option that best meets your needs and lifestyle, and keeps your bladder and kidneys healthy.

## Understanding your body

- The kidneys remove waste from your body through your blood stream. This waste becomes urine.
- The urine passes down the ureters (pronounced YOU-ret-erz) into the bladder. The sphincter (pronounced SFINK-ter) muscle at the end of the bladder acts like a valve that you can tighten to keep urine from leaving your body. (When you urinate, your sphincter normally relaxes and your bladder squeezes to push the urine out of your bladder).
- Urine passes from the bladder through the urethra (pronounced yur-EETH-rah) out of your body. In women, the urethra is right above the vagina. In men, the urethra is in the penis. The inability to control the release of urine is called urinary incontinence (pronounced in-KAHN-ten-ans). The inability to release urine from your bladder when it is full is called urinary retention.

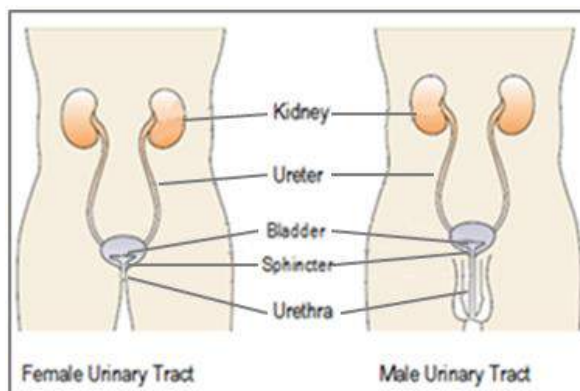

The Spinal Cord Injury Model System is sponsored by the National Institute of Disability, Independent Living, and Rehabilitation Research, U.S. Department of Health and Human Services' Administration for Community Living. Opinions expressed in this fact sheet are not necessarily those of the granting agency. (See <http://www.msktc.org/sci/model-system-centers> for more information).

## What does my spinal cord have to do with my bladder?

- Your brain sends and receives signals through your spinal cord. At the lowest part of your spinal cord (see [MSKTC factsheet entitled Understanding SCI Part 1](http://www.msktc.org/lib/docs/Factsheets/SCI_Understand_Spin_Crd_Inj_Prt1.pdf) [http://www.msktc.org/lib/docs/Factsheets/SCI\\_Understand\\_Spin\\_Crd\\_Inj\\_Prt1.pdf](http://www.msktc.org/lib/docs/Factsheets/SCI_Understand_Spin_Crd_Inj_Prt1.pdf)) is an area called the sacral micturition (pronounced SAY-krul mich-ter-ishun) center that has nerves attached to it that go to and from the bladder. These nerves help to signal the brain when the bladder needs to be emptied. They also control the sphincter.
- For example, if you need to hold your urine until a convenient time to empty your bladder, your brain will signal the bladder not to squeeze and the sphincter to tighten so that you can wait. When it is time to release your urine, signals from your brain will then send signals down your spinal cord to squeeze the bladder and relax the sphincter. If an SCI has damaged the spinal cord, the signals from the brain to the bladder do not work correctly and you might not be able to control your urine. You might not be able to stop urine from flowing (urinary incontinence), or you might not be able to release it (urinary retention).



## What bladder problems can an SCI cause?

An SCI can cause two types of bladder problems. One set of problems occurs immediately after injury, and the other may begin later on after your injury (long term) when you are out of spinal shock (see below)

Immediately after SCI:

- You might experience spinal shock, when signals from the brain can't get to any or most parts of the body below the spinal cord injury.
- Spinal shock in general usually lasts for up to a few days, but for the bladder it can last several months or longer.
- Your bladder does not squeeze when you are in the period of spinal shock.

After your bladder is out of spinal shock:

- Signals to and from your brain may still be blocked by the SCI.
- Your sacral micturition center is an area of the spinal cord at the base of the spine. This is the area of the spinal cord that controls your bladder and sphincter.
- After spinal shock, your sacral micturition center it might start sending signals on its own to tell the bladder to squeeze. In addition, signals that would normally come down from your brain to keep your sacral micturition center from sending signals to make your bladder squeeze are blocked by your SCI. Therefore your bladder begins to squeeze and possibly cause you to also urinate without control (urinary incontinence). This is known as a "neurogenic overactive bladder."
- Your sphincter might tighten or relax on its own, starting and stopping your urine stream without your control.
- Your bladder might try to squeeze but the sphincter might tighten at the same time, making you unable to urinate and causing a high-pressure buildup in the bladder. This is known as detrusor (bladder) sphincter dyssynergia (pronounced dis-IN-ergh-IAH). This can stretch your bladder beyond what is healthy and can cause bladder infections.
- High pressures in your bladder can also prevent urine from draining from your kidneys to your bladder and can cause kidney infections, kidney stones, and even kidney damage.
- Another problem that can occur in those with SCI at T6 and above is autonomic dysreflexia. This can happen when something causes pain or discomfort to your body even though you may not feel it. The two most common causes are bladder distention (and bladder contractions) and constipation. Autonomic dysreflexia causes a sudden severe elevation in blood pressure which has the potential of being dangerous. Autonomic dysreflexia may or may not (silent autonomic dysreflexia) cause other symptoms such as headache, flushing, and/or goose bumps. It will not get better until the cause of the autonomic dysreflexia is taken care of, such as emptying the bladder. (See the reference below for more details on acute autonomic dysreflexia.)
- Over time there are also risks of having other problems such as bladder or kidney infections and a slight risk of developing bladder cancer, bladder or kidney stones, or kidney damage.

## Does the level of injury on my spine affect what problems I experience?

- Yes, however everyone's bladder and sphincter act a little differently because the amount of nerve injury is a little different for each person even if you have the same level of injury as someone else.
- Keeping that in mind, the major areas to consider are:
  1. At or below the sacral micturition center
  2. Above the sacral micturition center.

### At or Below the Sacral Micturition Center:

- If the SCI damaged the spinal cord at or near the base of your spine, the sacral micturition center might be damaged.
- When this center is damaged, signals can't be sent to the bladder to tell the bladder to squeeze (neurogenic underactive bladder).
- If the damage is below your sacral micturition center then even though signals are sent towards the bladder, the nerves to the bladder are damaged so the signals do not reach the bladder and your bladder will not squeeze.
- Your bladder will then become very full (over distended).
- If you have a weak urinary sphincter, urine will probably overflow from your bladder without your control (urinary incontinence).
- If you have a strong urinary sphincter, urine may not be able to be released leading to a possible increase in bladder pressure and possible back-up of urine in your kidneys.

### Above the Sacral Micturition Center:

- The sacral micturition center sends signals to your bladder causing it to squeeze. Your spinal cord injury also blocks signals coming down from the brain which are telling the bladder when and when not to squeeze, causing you to have an overactive bladder. (See above section.)
- Signals also don't usually get to your urinary sphincter to tell it to relax when your bladder is squeezing (detrusor sphincter dyssynergia). (See above section.)
- If your injury is at T6 or above you may get autonomic dysreflexia from your overactive bladder and detrusor sphincter dyssynergia.

## How can I know if my bladder and sphincter are working correctly?

Doctors can do a uroynamics (pronounced yur-oh-di-NAM-iks) test to see how well your bladder and sphincter are working:

- A catheter (a small tube) goes up through your urethra into the bladder.
- Your bladder is slowly filled with fluid.
- Doctors then measure how your bladder and sphincter respond to the fluid in the bladder.
- The test can help inform which bladder management option is best for you.

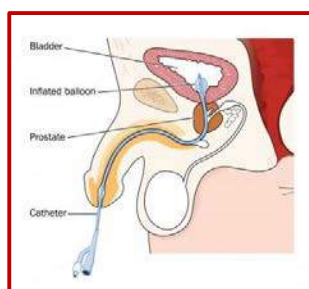

## What is bladder management?

Bladder management is an ongoing set of treatments and practices that help keep your bladder and kidneys healthy and free from infection and other problems.

- Bladder management cannot fix or solve the problems caused by your SCI, but it can help you manage them to improve your health and quality of life. With appropriate management you can prevent incontinence and damage to the kidneys.
- You can work with your doctor to choose which bladder management option fits into your lifestyle and maintains bladder and kidney health.

## What are some types of bladder management?

There are many types bladder management following SCI, each with various advantages and disadvantages. Several of the more common types of bladder management are listed below. It is important to speak with your health care provider to determine which option is best for you.

If you continue to have significant problems affecting your kidneys or bladder or your lifestyle despite non-surgical bladder management options, your doctor might in rare cases suggest a surgical option such as a urinary diversion. For more information on surgical management, see [MSKTC factsheet entitled \*Surgical Alternatives for Bladder Management Following SCI\*](http://www.msktc.org/sci/factsheets/bladdersurgery) <http://www.msktc.org/sci/factsheets/bladdersurgery>. This fact sheet will focus on some of the more common non-surgical options of bladder management.

### Intermittent Catheterization (pronounced kath-et-er-iz-AY-shun)

This option is used for draining your bladder without keeping a catheter in your bladder all the time.

- You (or someone else) insert a catheter into your bladder to keep your bladder from getting too full.
  - To do this, pass the catheter up your urethra into the bladder. The urine drains out the other end.
  - When done, remove the catheter and return to normal activities.
  - Do this as often as needed (usually 4-6 times per day). The goal is to keep your catheterization volumes less than 500 ml. (about 17 fl oz) so you may have to catheterize more or less often depending on how much you drink.
  - You will often need medication or injections (such as Botox) to keep your bladder quiet in order to prevent leaking and high pressures in your bladder.

- This option might NOT be for you if:
  - You are unable to catheterize yourself (or don't have someone to help you).
  - Your bladder is very small (so you would have to catheterize your bladder very frequently).
  - Your bladder is overactive (even with treatment; so you may have high bladder pressures or incontinence).
  - Your sphincter is overactive (will not relax easily; so the catheter will not pass easily into your bladder).
  - Your sphincter is underactive (will not tighten; so you will have frequent urinary incontinence).
  - You have a false passage in your urethra (so the catheter may get caught in the false passage).
  - You drink a lot of fluid (more than 2 -2 1/2 quarts or 2 liters) every day so you would need to catheterize very frequently).
  - You have a lot of pain when inserting or removing the catheter.
- You can use different types of catheters. Your doctor can help you decide which type of catheter is best for you. For example, the catheter might:
  - Have a slight curve at the tip. This is known as a Coudé (pronounced ku-DAY) catheter.
  - Have a bag attached at the end to catch the urine.
  - Be covered with lubricant to help it slide through your urethra.

#### Advantages:

- Intermittent catheterization simulates normal bladder filling which helps to maintain your normal bladder size
- You will not wear an internal or external catheter and leg bag all the time.

#### Disadvantages:

- You need to keep track of your fluid intake so that your bladder doesn't fill up too soon and get overstretched, especially while you are sleeping.
- You need to partially undress each time you use a catheter.
- You might find removing and inserting a catheter uncomfortable.
- If you are a woman, you might have trouble finding and passing your catheter into your urethra. You might cause some irritation or bleeding when passing a catheter into your bladder, especially if you are a man and have a very spastic urinary sphincter that tightens when you try to remove the catheter.
- You may need to take medication to keep your bladder from being overactive and causing urinary leakage.

### Indwelling Catheterization

This option is used for ongoing protection from urinary retention or urinary incontinence. Indwelling catheterization uses a catheter and a urine collection bag that stays in place all the time. The catheter has a balloon at the tip of the catheter which sits in your bladder. Once the catheter is in your bladder, the balloon can be inflated to keep the catheter from falling out or deflating when it's time to change the catheter.

There are two types of indwelling catheters: urethral catheters and suprapubic (pronounced soo-prah-PEW Bik) catheters. Most urethral catheters that are kept in place by filling up a balloon. People might call your indwelling catheter a Foley catheter.

#### Type 1: Urethral Catheters

A urethral catheter is inserted through your urethra, by yourself, by a physician, nurse or a trained family member using a similar technique as intermittent catheterization. However, instead of removing the catheter when your bladder is empty, the indwelling catheter stays in your bladder and is held in place in your bladder by a small balloon at the end. A small tube connects the other end of the catheter into a collection bag. It is not a good idea to plug your catheter, especially if you do not have good sensation in your bladder. If your bladder fills up and gets over distended, it can cause serious problems such as a bladder or kidney infections or autonomic dysreflexia (if your injury is at T6 and above).

There are several types of collection bags:

- Smaller bags can be strapped to your leg so that you can move freely.
- Some larger bags don't have to be drained as often and are used when you are sleeping (called night bags).

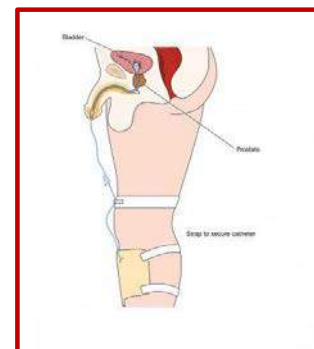

- A modified bag can be strapped around your waist (called a belly bag) instead of your leg.

A collection bag must be emptied frequently:

- A collection bag must be emptied several times a day to keep it from getting too full. It is best to try to empty the bag when it gets about one half full.
- If the bag gets too full, pressure may build up in the bag and keep the urine from flowing down the tube. Instead, the urine will back up. This could cause your bladder to become over stretched and cause problems such as bleeding, bladder infection, or autonomic dysreflexia.

A urethral catheter stays in place all the time. About once a month, the catheter is removed and a new one is put in place. This may be done sooner if the catheter gets blocked from bladder stones or if there are other problems with the catheter's drainage.

#### Advantages

- You do not need to worry about inserting and removing the catheter into your bladder several times a day.
- You do not need to limit the amount of liquid you drink.
- You do not need to undress to use the catheter.

#### Disadvantages

- About 3 out of 10 people who use a urethral catheter get bladder stones, which are small hardened pieces that collect and can block your catheter and cause your bladder to get overstretched. This can cause leaking around the catheter, pain, a urinary tract infection, hematuria (blood in the urine), or autonomic dysreflexia.
- You might have discomfort or pain from the catheter, especially when inserting or replacing it.
- You might be uncomfortable wearing a urine collection bag and worry about it leaking.
- It can be difficult to keep the area around the catheter clean, especially for women.
- A constantly empty bladder can reduce the size of your bladder, making it less able to hold more urine.
- You may need to take medication to keep your bladder from being overactive and causing urinary leakage.
- There can be sexuality issues due to having a catheter in the urethra.
- There may be a slight increase in bladder infections with urethral catheters but not suprapubic catheters compared to other types of management.

#### Type 2: Indwelling Suprapubic Catheter

In order to insert an indwelling suprapubic catheter, a doctor first needs to make a small incision below the beltline. This is done under an anesthetic. He or she then inserts the catheter through the incision into the bladder. Urine drains out from the catheter and is then stored in a collection bag on the outside of your body. The collection bag is drained as needed, to keep the bag from getting overfilled. The catheter is changed on a monthly basis just like a urethral catheter.

After the catheter has been put in by a doctor, the incision heals and there is a small hole so that the old catheter can be removed and a new catheter can be inserted. It is important to measure the distance that the catheter is in your bladder by marking the catheter at the skin level before removing it and then putting the new catheter in the same distance in. As long as a catheter is in the hole, it stays open. Once the catheter is removed the hole will close in 1-3 days. There are no restrictions with bathing or showering with a suprapubic tube. One study showed that in women, there were fewer bladder infections with a suprapubic tube than any other type of bladder management.

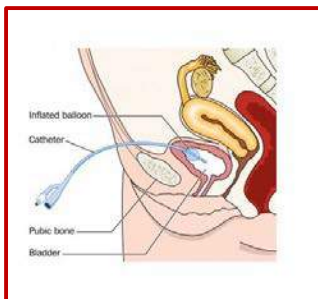

#### Advantages:

- Has all the advantages of a urethral catheter, and a suprapubic catheter also keeps you from feeling pain or discomfort from inserting and removing the catheter from your urethra.
- This catheter is easier to change than a urethral catheter. You do not need to lie down or undress to change the catheter.
- It is easy to keep the area around the catheter clean, and you are less likely to get an infection than with a urethral Foley catheter.
- It is preferable to a urethral catheter for sexuality reasons because the catheter is not in the urethra. If the suprapubic catheter becomes blocked or can't be removed, the urethra can sometimes act as a "pop off valve" releasing some of the urine, or the urethra can be used to pass a temporary urethral catheter.

**Disadvantages:**

- Like urethral catheters, there is an increased risk for developing bladder stones and a smaller bladder.
- You may need to take medication to keep your bladder from being overactive and causing urinary leakage.
- Same day surgery is needed to create the opening for the catheter.

**Reflex Voiding**

This option primarily is used by men with bladders that fill and squeeze on their own because a convenient way to capture urine is needed.

- This method usually uses an external condom catheter. These catheters fit like a condom around the penis and connect to a tube and collection bag. (There is no effective external collecting device for women.)
- This method requires a relaxed sphincter, and you might need help relaxing it. Methods of relaxing your sphincter include suprapubic bladder tapping (where you lightly tap the area over your bladder), medication, injections, and surgery.
- A man or a woman who uses a reflex voiding option might decide to have their bladder drain directly into a protective undergarment. Undergarments must be changed frequently to avoid the urine causing a skin rash.

**Advantages:**

- You do not need to limit your liquids.
- You do not need to undress to empty your bladder.

**Disadvantages:**

- Men need to wear an external condom catheter, and a leg bag or a protective undergarment to collect urine.
- Women must use a protective undergarment.
- Protective undergarments must be changed frequently.
- The skin around the penis might get irritated from the condom catheter being too tight.
- The external condom might twist or kink and fall off during voiding.
- If you have a “retractile” penis that pulls back into the abdomen, especially when you sit up, the condom catheter might not stay on.
- Additional treatment or medication might be needed to relax your sphincter, and these treatments could cause side effects.

**Valsalva and Credé Voiding**

This option is for people who have difficulty getting their bladder to squeeze. Credé (pronounced kre-DAY) is a method where you push inwards with a closed fist over your bladder to empty it. Valsalva (pronounced vahl-SAL-vah) is a method where you tighten your abdominal muscles and bear down to force urine from your bladder.

- The amount of bladder emptying depends on how much force you use to push urine from the bladder and how much your sphincter relaxes.
- While not recommended, people sometimes use crede or valsalva voiding in addition to their other type of bladder management. For example bearing down when they catheterize themselves to try to make their bladder empty a little quicker by forcing the urine flow through the catheter quicker or bearing down and forcing a little urine out of their bladder so they do not catheterize themselves as often.

**Advantages:**

- You do not need to use a catheter of any kind.

**Disadvantages:**

- The pushing or straining to empty your bladder can cause problems over time (such as hemorrhoids, hernias, and other medical problems).
- To catch the urine, you will need to undress and transfer onto a toilet, use a bed pan, or wear protective undergarments.
- It often takes a lot of effort and time to bear down in an attempt to empty your bladder.
- You may not be able to empty your bladder completely leading to complications such as UTI's and bladder stones.

## Summary

- Following an SCI, maintaining healthy kidneys and a healthy bladder are important. There are many bladder management options.
- Your doctor can help you find the best option for your needs and lifestyle.
- Your doctor can also help you decide when an option is working well, or if a new option needs to be considered.

## Reference

Consortium for Spinal Cord Medicine (2002). *Acute management of autonomic dysreflexia: individuals with spinal cord injury presenting to health-care facilities*. J Spinal Cord Med. 25, Suppl 1:S67-88.

## Authorship

Bladder Management Options Following Spinal Cord Injury was developed by Todd A. Linsenmeyer, M.D., and Steven Kirshblum, M.D., in collaboration with the Model Systems Knowledge Translation Center.

**Source:** Our health information content is based on research evidence and/or professional consensus and has been reviewed and approved by an editorial team of experts from the Spinal Cord Injury Model Systems.

**Disclaimer:** This information is not meant to replace the advice of a medical professional. You should consult your health care provider regarding specific medical concerns or treatment. The contents of this fact sheet were developed under a grant from the National Institute on Disability, Independent Living, and Rehabilitation Research (NIDILRR grant number 90DP0012-01-00). The contents of this fact sheet do not necessarily represent the policy of Department of Health and Human Services, and you should not assume endorsement by the Federal Government.

**Copyright © 2015** Model Systems Knowledge Translation Center (MSKTC). May be reproduced and distributed freely with appropriate attribution. Prior permission must be obtained for inclusion in fee-based materials.



***This fact sheet tells you about why a bowel program can improve your quality of life.***

## What you need to know

A spinal cord injury can lead to bowel problems:

- You may have problems moving waste through your colon (or large intestine).
- You may pass a stool when you don't want to, or a stool may be hard to pass.
- These problems can cause pain in your abdomen.
- When eating, you may feel full sooner than normal, or you may eat less than you usually do.
- Bowel problems can contribute to depression or anxiety. You may feel overly concerned about not being able to control bowel movements in public. You may not want to do things outside of your home.

A bowel program can help you to control bowel movements. Following a bowel program can help you to avoid other problems and perhaps bowel surgery.

## Understanding your body

Your stomach and small intestine pull nutrients from the food you eat. Nutrients keep you strong and give you energy. The rest of the food becomes waste that your body doesn't need. Waste forms into a stool in your colon and rectum and leaves your body through the anus. The process of passing a stool through and out of your body is known as a "bowel movement." If you have a spinal cord injury, this process may be tough for you. For example, you may have a difficult time passing stools. This is called "constipation." Or you may not be able to control when you pass a stool. This is called "stool incontinence."

Spinal cord injuries may cause tightness (spasticity) or looseness (flaccidity) in the muscles of the rectum, sphincters, and pelvic floor. The degree of tightness or looseness may be related to the severity or completeness and level of your injury. If your injury is above level T11/T12, then the muscles of your sphincters and pelvic floor may be tight, which leads to constipation. If your injury is level T11/T12 or lower, then these muscles may be loose, which leads to stool incontinence. People with incomplete spinal cord injuries tend to have more muscle strength and sensation and therefore have fewer bowel problems than people with complete injuries.

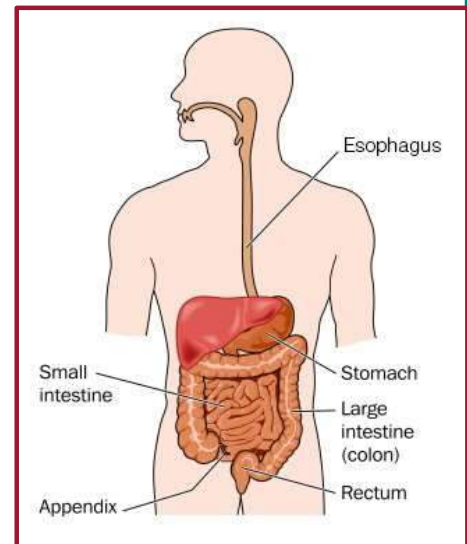

The Spinal Cord Injury Model System is sponsored by the National Institute on Disability and Rehabilitation Research, Office of Special Education and Rehabilitative Services, U.S. Department of Education. (See <http://www.msktc.org/sci/model-system-centers> for more information).

## What is a bowel program?

A bowel program is a plan to retrain your body to have regular bowel movements. A doctor or nurse designs a bowel program specifically for you. Your health, bowel and personal history, physical examination are an important part of this review:

- The level and completeness of your spinal cord injury
- Description and pattern of bowel problems
- Past and present medical problems

- Intake of food and drink
- Physical activities
- Need for or availability of resources
- Home environment
- Lifestyle
- Preferences
- Gastrointestinal tests

The goals of a bowel program are:

- Passing a stool every day or every other day
- Preventing unplanned bowel movements
- Emptying your bowel around the same time of day (e.g., morning, afternoon, or evening)
- Passing medium or large stool (about 2 cups) every time you have a bowel movement
- Emptying all or most of your rectum each day
- Having stools that are soft, formed, and bulky
- Emptying your bowel completely within 30 minutes (or 60 minutes, at most) after eating

## What is involved in a bowel program?

A bowel program includes four parts: timing, diet (including food and fluids), medicines, and techniques to help with bowel movements. The program isn't the same for everybody, because each person has different needs and responds differently to each part of the program.

### Timing

A bowel program is best when done every day or every other day. A program involves:

- Eating a good diet and drinking plenty of fluids
- Using bowel medicines, as recommended by your doctor
- Practicing techniques that activate the reflex to empty your rectum
- Using methods to clean out stools

### Diet and fluids

Eating a good diet and drinking plenty of fluids are important to bowel health:

- Natural fiber from fruits and vegetables increases the bulk of stool, making it easier to move through the colon. Doctors recommend 38 grams of fiber per day for men and 25 grams per day for women.
- When eating a diet high in fiber, you should drink plenty of fluids. Water is best. You may get constipated if you don't drink enough fluids. You should drink at least 2 or 3 quarts of fluids every day, unless told otherwise by your doctor.
- You should limit your intake of liquids with caffeine (e.g., coffee, tea, or energy drinks). These drinks actually remove fluids from your body.

### Medicines

Your doctor may have you take one or more medicines, either orally or rectally:

- Stool softeners make stools soft and easy to move.
- Stimulant laxatives stimulate the colon to move stools.
- Bulking laxatives add shape and form to stools and prevent diarrhea (watery stools).
- Rectal laxatives help with rectal movement and emptying.

Some medicines may cause constipation. They may be ones that you're taking already to reduce pain or muscle spasms or to treat depression. You may benefit from minimizing your use of these medicines under the supervision of your physician:

- Medicines to reduce pain, such as hydrocodone, oxycodone, morphine, fentanyl, gabapentin, pregabalin, or carbamazepine
- Medicines to treat bladder spasms but slow down intestinal motility, such as oxybutynin or tolterodine
- Medicines to stop muscle spasms all over the body, such as lioresal, tizanidine, or diazepam
- Medicines to treat depression, such as cymbalta, sertraline, or citalopram



## Techniques

You can do one or more techniques to help you have a bowel movement and empty your rectum. You can do these at home or with help from a caregiver or nursing aid.

- **Digital rectal stimulation:** Move your fingertip in a small, gentle, circular motion around the rectum/anus. This motion stimulates reflex of the rectum/anus. Be sure to cut your fingernails short to avoid trauma. Perform this technique for 20 seconds and repeat it every 5–10 minutes until the bowel program is completed and the rectum is empty.
- **Digital removal of stool:** Use your finger to remove stool from the rectum. This will speed up your ability to empty the rectum.
- **Enema:** Use a device to flush warm water into your rectum, which will help to empty it of stool. Examples of devices include the catheter enema or cone enema. If these simple enemas do not work, other home stool evacuation devices like the Peristeen enema and PIE (Pulsed Irrigation Evacuation) systems which have been approved by the U.S. Food and Drug Administration may help.

## What if I can't do a bowel program or it doesn't work?

A serious injury may keep some people from carrying out a bowel program. For others, the program just may not work. Every person is different. Surgery may be a good option in a few cases, for example:

- If you can't achieve regular, complete bowel movements, which can lead to recurrent severe constipation (associated with frequent hospital admissions for stool loading and obstruction; chronic abdominal pain; prolonged [ $>1$  hour], difficult bowel programs; or severe autonomic dysreflexia<sup>1</sup>).
- If you have frequent stool incontinence (associated with pressure sores) or lack caregiver support, both of which may contribute to a poor quality of life and confinement in the home.

Other options include two kinds of surgery.

### Colostomy

Surgeons attach the colon to the abdominal wall through a hole called a "stoma" (or opening). A bag is attached to the stoma. Stools pass into the bag instead of through the rectum. You or a caregiver empty and change the bag easily and regularly. (The end of colostomy is shown in the image.)

Most people who have the colostomy choose to have it permanently. The colostomy promotes good bowel movements and is easy to manage by yourself or by a caregiver. The procedure prevents stool incontinence and unplanned bowel movements. It also decreases mental stress so you can do more activities outside the home with family and friends.



### Antegrade Continence Enema

Surgeons open the abdominal wall to create a tract to either the first part of the colon (ascending colon) or the last part of the colon (descending colon/sigmoid) (See figure). You or a caregiver place an enema catheter through the stoma daily to flush the stool out of the colon with 500–1000mL of tap water. This process usually lasts from 30 to 60 minutes. Cleansing the colon daily and regularly prevents unplanned *bowel* movements and stool incontinence.

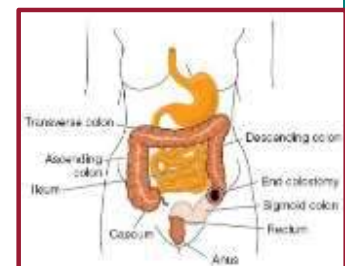

<sup>1</sup> Autonomic dysreflexia (pronounced aw-to-nom-ik dis-ree-FLEKS-ee-ah) is a serious condition in which dangerously high blood pressure is associated with a drop in heart rate in people with spinal cord injury at levels T6 and above. It may cause heavy sweating, flushing, headaches, and blurry vision. If left untreated, the condition may lead to stroke, bleeding in the eyes, swelling of the heart or lungs, and other severe health problems.

## Why is maintaining bowel function so important?

Worsening and untreated bowel function can lead to other health problems:

- Partial paralysis of the stomach
- Chronic heartburn
- Gas pain
- Stomach or intestinal ulcers
- Hemorrhoids
- Abdominal discomfort, pain, or distension
- Nausea
- Bloating or fullness
- Change in weight (related to a poor diet or a decrease in appetite)
- Autonomic dysreflexia - This is a serious condition where a dangerous elevation in blood pressure is associated with a drop in heart rate in people with spinal cord injury at levels T6 and above. It may cause heavy sweating, flushing, headaches, and blurry vision. If left untreated, it may lead to stroke, bleeding in the eyes, swelling of the heart or lungs, and other severe health problems.
- Worsening pain and/or spasticity
- Decreased sense of well-being

These health problems can reduce your quality of life. But you may be able to avoid these problems by following a bowel program every day. Your doctor or nurse can help you and will check with you to see how you're doing. Ask questions, and let your health care professional know about any problems you're having.

## Authorship

*Bowel Function Problems After Spinal Cord Injury* was developed by Gianna M. Rodriguez, M.D., in collaboration with the Model Systems Knowledge Translation Center

**Disclaimer:** This information is not meant to replace the advice of a medical professional. You should consult your health care provider regarding specific medical concerns or treatment. The contents of this fact sheet were developed under a grant from the National Institute on Disability, Independent Living, and Rehabilitation Research (NIDILRR grant number 90DP0012-01-00). The contents of this fact sheet do not necessarily represent the policy of Department of Health and Human Services, and you should not assume endorsement by the Federal Government.

**Copyright** © 2015 Model Systems Knowledge Translation Center (MSKTC). May be reproduced and distributed freely with appropriate attribution. Prior permission must be obtained for inclusion in fee-based materials.





This fact sheet tells you about resources and steps you can take to help you return to driving after your spinal cord injury (SCI).

The Spinal Cord Injury Model System is sponsored by the National Institute of Disability, Independent Living, and Rehabilitation Research, U.S. Department of Health and Human Services' Administration for Community Living. (See <http://www.msktc.org/sci/model-system-centers> for more information).

## What you need to know

- You may be able to continue driving safely again, depending on how serious your injury is and how much function you have regained.
- If you can drive, you may need to buy a vehicle that suits your unique needs after the injury.
- Vehicles can be altered with special equipment called "assistive technology" to help you drive safely after your injury.
- Equipment can be expensive based on your function and the type of equipment necessary.
- You should take specific steps before you return to driving; there are resources to help you.

## How do I know if I can drive a vehicle again?

The amount of time after your injury is a major factor in deciding whether and how you can return to driving. You may see many improvements in your abilities several weeks or months after your injury. With time, you may regain some functions that could make driving

possible. With time, the amount and cost of any needed special equipment may be reduced. You should look for these important signs that you are ready to drive again:

- You do not need narcotics to control your pain while you drive.
- You have good vision, or your vision can be corrected.
- You can control the muscle spasms and muscle tightening caused by the injury.

Your doctor can refer you to a driving rehabilitation specialist for a full evaluation to decide if you are ready and able to drive.

A full driving assessment will evaluate:

- Medical data/driving history/driving goals
- Vision
- Strength and range of motion
- Cognitive ability (if indicated)
- Ability to transfer
- Wheelchair or other mobility device loading
- Behind-the-wheel driving to try out equipment options

***You might be able to drive safely with special assistive equipment for your vehicle. The equipment can be expensive. Obtaining a driving assessment may help minimize costs.***

## How to find out what kind of assistive technology I will need.

Your doctor can refer you to a Certified Driver Rehabilitation Specialist (CDRS) near you who can do a driving evaluation for you. You can find a list of specialists and their locations at <http://www.aded.net/> or by calling ADED at 866.672.9466.

The CDRS can help you decide what special equipment you might need to drive a vehicle, and what type of vehicle would be best suited to your needs. The CDRS may also know about special funding to help you get the equipment you need. To be evaluated by a CDRS, you will most often need a referral from a doctor. If you live in an area where there is not a CDRS close by then we recommend you visit <http://www.nmeda.com/>, and use the dealer locator tool to find automotive mobility dealers closest to you. These dealers are specially trained to help with your driving equipment needs. They will know of professionals in your area that can best meet your needs. NMEDA's phone number is (866) 948-8341.

## What kind of assistive technology is available?

There is assistive technology for many activities associated with driving; your choice will depend on what you need:

**Getting in and out of a vehicle:** Two of the main factors to consider in the return to driving after an SCI are vehicle entry and exit, and loading and unloading the mobility device if you use one.



An example of a wheelchair lift for a pickup truck.

Photo courtesy of Shepherd Center.

- You may be able to transfer from a wheelchair into the vehicle and then load the manual wheelchair on your own.
- If you cannot load your wheelchair, there are adaptive wheelchair loading devices like the one shown on the left.
- If you cannot safely and independently transfer from the wheelchair to the driver's seat, you may need a wheelchair-accessible vehicle that lets you drive or push your wheelchair into the vehicle.
- Some modified vehicles let you drive while sitting in the wheelchair.
- Whichever device you choose, the wheelchair must be secured while the vehicle is moving.

**Operating the gas and brake controls:** There are many different types of gas and brake controls; the most common are hand controls. Hand controls are available with many types of motion—push-pull, push-twist, push-rock, and push-right angle—so that drivers can use the one that suits them best. A CDRS can help you choose the best type for your injury or disability.

Controls can be mounted for the left or right hand. Pictured here is a right-floor-mounted mechanical hand control. Also a removable accelerator pedal block and steering wheel spinner knob can be seen. Photo courtesy of Shepherd Center.



**Steering.** Often a driver using hand controls will use only one hand for the steering wheel because the other hand is controlling the gas. A steering device like the one pictured here can help a driver steer efficiently with only one hand. The device can be placed on either side of the steering wheel, depending on which arm is strongest. The steering system can also be adapted so the driver can turn the wheel with less force using a smaller steering wheel, a separate electronic steering wheel, or even a foot-operated steering device.



Electronic Wheel to be used with right hand for steering.



Electronic Gas/Brake Lever used with left arm and Electronic Wheel used with right arm for steering.



A tri-pin steering device allows someone without finger function to turn the steering wheel.

*Photos courtesy of Shepherd Center.*

## How will I pay for this equipment?

Assistive equipment can be expensive. An accessible vehicle can cost a few hundred more than a basic vehicle all the way to over \$100K based on your situation. Costs include equipment, installation, training, insurance, and upkeep. You might be able to get help to pay for these costs. Some options include:

- Your State's vocational rehabilitation (VR) program might help you buy, equip, and learn to use a vehicle. VR programs usually are for people who plan to return to school or work and who need costly high-tech equipment and/or a wheelchair-accessible vehicle.
- Most vehicle companies offer a rebate (about \$1,000) to qualified people who buy a new vehicle. These rebates usually limit what equipment can be purchased.
- The Crime Victims' Compensation Program might help if you are a victim of a crime (such as gunshot, drunk driver, violence). For more information, go to <http://victimsofcrime.org>, or call (202) 467-8700.
- Your State might have a trust fund that could help you. (For example, The Georgia Brain and Spinal Injury Trust Fund Commission helps Georgia residents with uninsured costs related to disability, including buying or modifying a vehicle. For more information, go to <http://www.ciclt.net/bsitf>.)
- HelpHOPELive helps organize community-based fundraising efforts to help cover the costs of uninsured medical expenses for people with tragic injuries. For more information, go to <http://www.helphopelive.org/about/>.
- The U.S. Department of Veterans Affairs, or VA, offers grants to veterans who become disabled due to disease or injury associated with their military service, or who become disabled as a result of therapy, rehabilitation, or medical treatments provided by the VA. For more information, go to <http://www.va.gov/>.

## When is the best time for me to get started?

Timing is everything. Take your time and get all the facts. Your body might need time to adjust to the effects of your SCI. For example, your motor functions might be different 1 month after your SCI than even a few to several months later. We urge you to take the time you may need after your SCI to be evaluated by a CDRS. The CDRS will evaluate your skills and help you decide what vehicle and equipment you will need. If you use a wheelchair, it will be important to coordinate your new chair with any plans for driving and also to have your own chair available before you purchase a vehicle so that the vehicle choice can support you and your chair.

Remember, an adapted vehicle can be expensive. It is important to truly understand your needs before buying anything. Do not feel pressured to make quick decisions. Rushing into a purchase will almost always make an appropriate vehicle more expensive than when a full evaluation is made at the proper time. When a purchased vehicle cannot be adapted to meet your needs, money and time are wasted in selling it and then buying a well-matched vehicle.

## Authorship

*Driving after Spinal Cord Injury* was developed by John Anschutz in collaboration with the Model Systems Knowledge Translation Center.

**Source:** Our health information content is based on research evidence and/or professional consensus and has been reviewed and approved by an editorial team of experts from the Spinal Cord Injury Model Systems.

**Disclaimer:** This information is not meant to replace the advice of a medical professional. You should consult your health care provider regarding specific medical concerns or treatment. The contents of this fact sheet were developed under a grant from the National Institute on Disability, Independent Living, and Rehabilitation Research (NIDILRR grant number 90DP0012-01-00). The contents of this fact sheet do not necessarily represent the policy of Department of Health and Human Services, and you should not assume endorsement by the Federal Government.

**Copyright** © 2015 Model Systems Knowledge Translation Center (MSKTC). May be reproduced and distributed freely with appropriate attribution. Prior permission must be obtained for inclusion in fee-based materials.





This fact sheet explains the important role that exercise and nutrition play after a spinal cord injury (SCI). It also describes some problems areas to watch for as you plan your exercise activities.

## Summary

- ◆ If you have a spinal cord injury (SCI), you can and should be physically active.
- ◆ Your health will benefit from regular exercise after SCI.
- ◆ Your exercise program should include three parts: stretching, aerobic exercise, and strength training.
- ◆ Setting goals, recognizing potential barriers, being prepared, and learning about resources can help you have a successful exercise program.
- ◆ With so many options, you can find an exercise program that is right for you.

## Introduction

People with SCI are more likely than the general population to have health problems related to weight gain, changes in cholesterol, and high blood sugar. People with SCI are also at higher risk of cardiovascular disease. Not being active may contribute largely to these problems.

Normal, everyday activities aren't enough to maintain cardiovascular fitness in people with SCI. Regular exercise can help to reduce the risk of health problems after SCI.

## Importance of Regular Physical Activity

- ◆ Improves energy levels and ability to take part in activities
- ◆ Strengthens muscles
- ◆ Increases flexibility
- ◆ Improves mood
- ◆ Improves sleep
- ◆ Decreases pain
- ◆ Helps achieve and maintain a healthy weight
- ◆ Improves cholesterol
- ◆ Improves blood sugar
- ◆ Decreases the risk of heart disease

Because of these benefits, exercise is more than just fun—it's a form of medicine that can be a powerful tool for preventing and treating many health conditions.

The Spinal Cord Injury Model System is sponsored by the National Institute of Disability, Independent Living, and Rehabilitation Research, U.S.

Department of Health and Human Services' Administration for Community Living.

(See <http://www.msctc.org/sci/model-system-centers> for more information).

## Exercise Guidelines

Exercise should include stretching, aerobic exercise, and strength training. The Centers for Disease Control and Prevention (CDC) recommends three exercise options for adults:

- ◆ 150 minutes of moderate-intensity aerobic exercise every week and strength training 2 or more days per week. Strength training should focus on all possible major muscle groups.

OR

- ◆ 75 minutes of vigorous-intensity aerobic exercise every week and strength training 2 or more days per week, to work all possible major muscle groups.

OR

- ◆ An equal mix of moderate- and vigorous-intensity aerobic exercise and strength training 2 or more days per week, to work all possible major muscle groups.

If you can't meet these guidelines, then exercise regularly based on your abilities. Avoiding inactivity is very important. Any amount of exercise is better than no exercise. Talk to a trainer, physical therapist, clinical exercise physiologist, or your doctor for more guidance. For more information, consult [CDC's Physical Activity Guidelines](http://www.cdc.gov/physicalactivity/everyone/guidelines/) (<http://www.cdc.gov/physicalactivity/everyone/guidelines/>).

### Stretching

People with SCI should stretch regularly to prevent and treat stiff muscles and joints. A good flexibility program should stretch all major muscle groups. You should focus on your shoulders, hips, knees, and ankles, because these are common areas of tightness after SCI. Stretching can be done by yourself or with help from a trainer, therapist, aide, family member, or friend. You should stretch most days of the week. Some people with SCI even find it helpful to stretch many times per day. Start out by gently stretching each muscle group for at least 30 seconds. Repeat the stretch a second time, trying to go a little bit further. Also consider stretching before and after aerobic exercise and strength training.



*Using an arm crank machine (ergometer) is one option for aerobic exercise that may be available at your local gym.*

### Aerobic Exercise

Aerobic exercise is particularly good for cardiovascular health. You can use the "talk test" to help gauge the intensity of your workout. The test is quite easy. If you are doing moderate-intensity exercise, you should be able to talk but not sing. If you are doing vigorous-intensity exercise, you shouldn't be able to say more than a few words without pausing to take a breath. Aerobic exercise should include three phases:

- ◆ Warm up by stretching and doing a light intensity activity. These slowly increase your heart rate and warm up your muscles.
- ◆ Exercise at a moderate or vigorous intensity (based on the talk test).
- ◆ Cool down by doing a light intensity activity. This slowly decreases your heart rate.

### Strength Training

Strength training can be done on the same or different day as your aerobic exercise. But it doesn't count toward your time for aerobic exercise. Strength training should target major muscle groups that you can control. These muscles will differ for everyone depending on their SCI. To start, plan to perform each exercise at least 10 times (10 repetitions = 1 set). Take a short break. Repeat each set one or two times. To get the most out of strength training, perform to a point where it is hard for you to do another repetition without help.

### Scheduling Exercise

It is best to exercise in routines of at least 30 minutes. But even as little as 10 minutes of physical activity at a time can provide health benefits. If possible, spread out your exercises throughout the week. The more time you spend exercising, the more health benefits you'll get!



*Some individuals may choose to use free weights for strength training.*



## Options for Exercising

One of the great things about exercise is that so many options exist. Exercise can occur as part of your daily routine, such as walking or wheeling to work. Exercise can be done in your home (e.g., following an exercise video), at a gym, or in the community. You can exercise alone or with others.

Examples of stretching include:

- ◆ Yoga
- ◆ Laying on your stomach
- ◆ Using a standing frame
- ◆ Using exercise bands

Examples of aerobic exercise include:

- ◆ Hand cycling
- ◆ Rowing
- ◆ Circuit training
- ◆ Swimming
- ◆ Playing wheelchair basketball
- ◆ Pushing your wheelchair briskly (if you use a wheelchair)

Examples of strength training include:

- ◆ Weightlifting
- ◆ Using resistance bands
- ◆ Yoga

You might need special equipment to exercise, depending on your needs and how and where you choose to exercise, for example:

- ◆ Straps to improve positioning, stability, and balance while exercising
- ◆ Cuffs or wraps to help grip the exercise equipment
- ◆ Body weight support
- ◆ Electrical stimulation to help exercise muscles that are below the level of the injury

## Where to Start

1. Think about your goals for physical activity. This will be different for everyone. Here are some examples:

- ◆ Become physically fit and improve your heart health
- ◆ Lose weight and use less medicine
- ◆ Be active and enjoy the outdoors
- ◆ Make friends at a gym or exercise class

Choose goals that you can attain. But the goals should be challenging too—think big! Write down your goals, and refer to them a lot. Use your goals to motivate and to remind you why you started exercising.

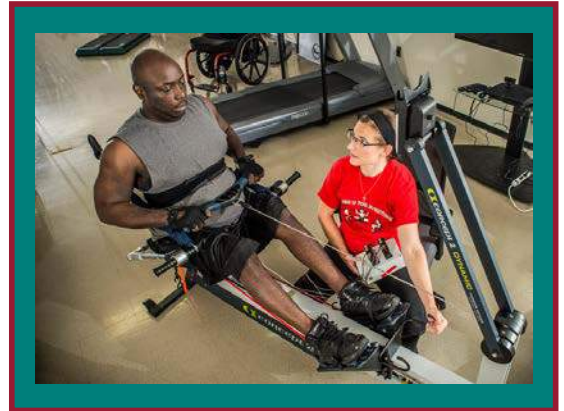

*When using exercise equipment, a chest strap can be helpful to provide trunk stabilization.*



*Equipment such as kettle bells can be used for strength training in individuals with decreased hand function.*

2. Think about a location that is best for you to exercise and keep an exercise routine. You should consider your level of mobility, options for transportation, whether you prefer to exercise alone or in a group, and accessibility of local fitness centers. There is no right or wrong place. Focus on a setting that will give you the best chance for success. For example, if you know that you'll need support and encouragement from other people, then a home-based exercise program is probably not the right choice for you.

Ask yourself the following questions:

- ◆ Do I want to exercise at home or at a fitness center? Inside or outside?
- ◆ Do I want to exercise by myself or with others?
- ◆ What equipment will I need to exercise? Where can I get it?
- ◆ Am I interested in fitness classes? If so, when and where are they offered?
- ◆ What options do I have for transportation?
- ◆ Will I be able to access the local fitness center? Are the lockers, showers, and restrooms accessible?
- ◆ When is the fitness center open? Do these hours work for me?
- ◆ Will I receive assistance and expert help?
- ◆ What fitness plan can I afford?

3. Learn more about the resources in your community. Talk to your doctor or physical therapist about your goal to exercise regularly. Do they have any suggestions? Talk to other people with SCI in your community. Where do they exercise? What resources do they find helpful? If you live in or near a city, look for a hospital or rehab center in which staff work with people with SCI. They may know of local, accessible exercise programs and recreation resources. Check out places like the YMCA. Are its facilities accessible? Does it have trainers who know how to work with people with SCI? The first few places you contact may not be right for you. Don't give up.

4. Finally, choose an engaging activity—one that excites you. And stick with it!

## Ready? Set? What's Next?

Go easy as you start to exercise. If you're not used to exercising, give your body time to adapt to being active. If you have not exercised recently, you should first get comfortable doing moderate-intensity activities before adding more vigorous-intensity activities. Don't give up if you don't like the activity that you chose. With so many options, you can always choose another activity.

## Eat Right

Make the most of your exercise program by also eating right. Like exercise, good nutrition can help to manage blood pressure and cholesterol and decrease your risk of diabetes and heart disease. Eating right promotes a strong immune system and helps to prevent skin breakdown. A good diet will also give you the energy you need to exercise:

- ◆ Eat breakfast.
- ◆ Eat small portion sizes.
- ◆ Eat five servings of fruits and vegetables per day.
- ◆ Eat lean protein, such as chicken and fish, instead of red meat.
- ◆ Limit eating processed foods and foods high in fat.
- ◆ Choose healthy snacks between meals.
- ◆ Stay hydrated.

For more information about nutrition and eating right, consult [Weight Management Following Spinal Cord Injury](http://images.main.uab.edu/spinalcord/SCI%20Infosheets%20in%20PDF/Weight%20Management%20following%20SCI.pdf) (<http://images.main.uab.edu/spinalcord/SCI%20Infosheets%20in%20PDF/Weight%20Management%20following%20SCI.pdf>).



## Troubleshooting

### Overcome Barriers to Getting Involved

Even if you really want to exercise, some barriers may make starting more difficult than you might think, for example:

- ◆ Being unsure of what to do
- ◆ Being unsure of where to go
- ◆ Financial barriers
- ◆ Finding and scheduling reliable transportation
- ◆ Fear of stigma and negative attitudes
- ◆ Health-related concerns, such as skin breakdown, shoulder pain, autonomic dysreflexia, or changes to your bowel and bladder management.

These problems are common. But know that you aren't alone. Talk to your trainer, therapist, doctor, or friends to help find the best solution. Every person is different. Every solution is unique. Don't give up!

### Stay Committed

Here are some tips to stay on track with your exercise program:

- ◆ Remember your goals.
- ◆ Plan out your activities weekly. Have reasonable expectations.
- ◆ Exercise at the same time of day so it becomes part of your regular routine.
- ◆ Keep track of your progress by writing your exercises in a calendar or journal.
- ◆ Be flexible. If something comes up and you can't exercise as planned, work physical activity into your day in other ways.
- ◆ Make exercise fun. Try working out with other people, adding some variety to your exercise routine, or listening to music or audiobooks.
- ◆ Celebrate success!

## Be Aware of Potential Health Problems

Exercise should be fun and safe. But you should always be on the lookout for potential problems.

### Skin Breakdown

Many people with SCI have changes or lack feeling below the level of the injury. For example, you may not be able to feel a new cut on your skin. Exercise may increase pressure or friction on the skin. This can increase the risk of skin breakdown.

What to do:

- ◆ Pay special attention to the surface on which you sit or lay.
- ◆ Use your wheelchair cushion whenever possible, especially on hard surfaces.
- ◆ Secure yourself to the exercise surface to avoid increased friction.
- ◆ Perform weight shifts every 30 minutes for 2 minutes.
- ◆ Check your skin daily.
- ◆ Tell your doctor if you have an area of skin that gets red regularly when exercising or gets red and doesn't go away.

## Temperature Regulation

People with SCI may not be able to keep a safe body temperature when exercising. Sweating normally cools you down during exercise. If you don't sweat below the level of the injury, you can overheat quickly. Overheating can even happen when it is cool outside. On the other hand, you may not be able to stay warm when you exercise in the cold.

What to do:

- ◆ Drink water or fluids before, during, and after exercise.
- ◆ Wear clothing in layers so you can adjust as needed.
- ◆ In warm weather, use a cold towel or spray bottle to help you stay cool.
- ◆ In cold weather, make sure that your arms, hands, feet, and legs don't get too cold.

## Orthostatic Hypotension

Some people with SCI experience a drop in blood pressure when in an upright position. This is known as orthostatic hypotension. It tends to occur most often when changing from a lying position to sitting or from a sitting position to standing. It can also occur when sitting or standing for a long period of time.

People with a SCI level above T6 have an increased risk of orthostatic hypotension. Common symptoms include lightheadedness, dizziness, and nausea.

What to do:

- ◆ If the exercise calls for sitting or standing, make sure you can first tolerate that position.
- ◆ Avoid quickly moving from lying to sitting or from sitting to standing.
- ◆ Stay hydrated.
- ◆ If you develop symptoms, try using compression stockings and an abdominal binder when exercising.
- ◆ If you have symptoms of orthostatic hypotension, lay on your back with your feet elevated until your symptoms go away.
- ◆ Talk to your doctor if your symptoms make it hard for you to exercise.

## Autonomic Dysreflexia

After SCI, your body may change the way it responds to pain, discomfort, or irritation below the level of the injury. Even if you can't feel below the level of the injury, your body can find a way to tell you that something is wrong. One way may be through the quick onset of very high blood pressure. This is known as autonomic dysreflexia (AD).

AD can be deadly if not treated. People with a SCI level above T6 are at risk of AD. Common symptoms include headache, sweating, nausea, goosebumps, and a stuffy nose. Anything that would cause pain below the level of the injury can cause AD. Examples include full bladder or leg bag, constipation, tight clothes, pressure sore, blister, ingrown toenail, urinary tract infection, or broken bone.

What to do:

- ◆ Learn about and notice the symptoms of AD. Check out the MSKTC factsheet on AD at <http://www.msktc.org/sci/factsheets>.
- ◆ If you have symptoms while exercising, stop right away and try to determine and reverse the cause:
  - Sit up.
  - Loosen any tight clothing.
  - Check your bladder (is your leg bag full, is your catheter draining, or do you need to catheterize).
  - Move off of any pressure sores or high pressure areas.
  - Seek medical help quickly if your symptoms don't go away.

## Overuse Injuries

People with SCI are at risk for overuse injuries. These types of injuries occur when you use the same muscles and movements for both everyday activities and exercise. Shoulder pain is the most common overuse injury in people with SCI.

What to do:

- ◆ If possible, consider alternatives to wheelchair pushing for exercise.
- ◆ Practice good body mechanics when exercising (and with everyday activities).
- ◆ Balance routines of stretching, aerobic exercise, and strength training. Remember, a good exercise program includes all three parts.
- ◆ Talk to your trainer, therapist, or doctor about new or increasing pain. They may want to alter your exercise program and daily activities or develop a treatment plan.

## Bone Loss and Broken Bones

People with SCI who don't walk regularly are at risk of weaker bones or bone loss below the level of the injury. This bone loss increases the risk for broken bones—even after only mild trauma, such as twisting your leg or falling from your wheelchair. Because of changes in sensation in some people after SCI, you may not even be aware of a broken bone.

What to do:

- ◆ Talk to your doctor about your risk for bone loss and broken bones before starting a new exercise program.
- ◆ Talk to your doctor about whether or not any medications or supplements may be helpful in optimizing your bone health.
- ◆ Seek medical attention if you notice any new pain, swelling, or redness or increased AD

## Additional Resources

The [CDC's Physical Activity Guidelines](http://www.cdc.gov/physicalactivity/everyone/guidelines/) (<http://www.cdc.gov/physicalactivity/everyone/guidelines/>) includes definitions for exercise.

American Congress of Rehabilitation Medicine has created a guide with exercise [recommendations and considerations for persons with spinal cord injury](http://www.archives-pmr.org/article/S0003-9993(15)00118-5/pdf) ([http://www.archives-pmr.org/article/S0003-9993\(15\)00118-5/pdf](http://www.archives-pmr.org/article/S0003-9993(15)00118-5/pdf)).

The [National Center on Health, Physical Activity and Disability](http://www.nchpad.org) (<http://www.nchpad.org>) offers a lot of information about exercise, nutrition, weight loss, and advocacy initiatives for people with disabilities. For example, "[14 Weeks to a Healthier You](#)" can help you set up an exercise and nutrition program that's right for you.

## Authorship

Exercise After Spinal Cord Injury was developed by Cheri Blauwet, M.D., and Jayne Donovan, M.D., in collaboration with the National Center on Health, Physical Activity and Disability (NCHPAD) and the Model Systems Knowledge Translation Center. Credit for these images goes to Lakeshore Foundation and NCHPAD.

**Source:** Content is based on research and/or professional consensus. Editorial experts from the Spinal Cord Injury Model Systems reviewed and approved this content.

**Disclaimer:** The content of this factsheet does not replace the advice of a medical professional. You should consult a health care provider about specific medical concerns or treatment. This fact sheet was developed under a grant from the National Institute on Disability, Independent Living, and Rehabilitation Research (NIDILRR grant number 90DP0082). This content may not represent the policy of the U.S. Department of Health and Human Services. The federal government may not endorse this content.

**Copyright © 2016** Model Systems Knowledge Translation Center (MSKTC). You can freely reproduce and distribute this content. Include proper attribution. But you must get permission before using this content in fee-based products.





*This fact sheet helps women prepare for pregnancy, labor and delivery after a spinal cord injury. It also gives tips on how you can work with your health care team to keep you and your baby healthy.*

## Are you thinking about getting pregnant?

Having a spinal cord injury (SCI) does not affect your ability to naturally become pregnant, carry, and deliver a baby, so your decision to have children is made in much the same way as anyone else. You consider the demands and challenges of parenting and how you might manage them. Here are other facts to consider when deciding whether or not you want to have children.

- Women with all levels of injury have had children after injury. You should also be able to if you choose.
- The positive aspects of parenting usually outweigh the difficulties.
- [www.lookingglass.org](http://www.lookingglass.org) and [www.disabledparents.net](http://www.disabledparents.net) are good online resources for women with SCI who are pregnant or want to get pregnant.

## What do I do if I am pregnant or want to get pregnant?

Here is a checklist of things to do help you plan for a healthy pregnancy.

- ✓ **Get a complete GYN exam.** This will give you the opportunity to get pre-conception counseling, Pap smear testing, assessment of immunizations, family history, as well as screening for genetic testing.
- ✓ **Talk to a rehabilitation doctor who knows about women's health after SCI.** This doctor, sometimes known as a physiatrist (pronounced fizz-ee-a-trist), can talk with you about your injury and explain what it means for your pregnancy, labor, and delivery. A physiatrist can also help you find an obstetrician (pronounced ob-ste-trish-in) or other medical specialists you may need during your pregnancy.
- ✓ **Get your medicines checked.** Many prescription and over-the-counter medicines are not to be taken if you are pregnant or want to get pregnant. When you go to the obstetrician, take *all* of your medicines with you. You may need to adjust your medicines to keep your baby healthy.
- ✓ **Get a urology check-up.** The growing baby will put pressure on your bladder. Getting a complete check-up of your urinary tract (kidneys, bladder, ureters) before you get pregnant is important. You and your obstetrician will use the test results to plan and prepare as your body changes during pregnancy.
  - **NOTE:** Tell your doctor if you are pregnant or think you might be pregnant. Some tests, such as x-rays, can harm your baby.

The Spinal Cord Injury Model System is sponsored by the National Institute of Disability and Rehabilitation Research, U.S. Department of Health and Human Services' Administration for Community Living. Opinions expressed in this fact sheet are not necessarily those of the granting agency.

For more information, contact your nearest SCI Model System. For a list of SCI Model Systems go to <http://www.msctc.org/sci/model-system-centers>

## What happens during pregnancy?

Your injury does not impact your baby. Your baby will develop as all babies do. This means you need to follow the advice of your obstetrician to take care of your baby. You may also have the same common discomforts of pregnancy that other women have.

- |                         |                                   |
|-------------------------|-----------------------------------|
| • Headaches             | • Heartburn and indigestion       |
| • Body aches and pains  | • Swelling in the feet and ankles |
| • Numbness or tingling  | • Hemorrhoids                     |
| • Fatigue               | • Shortness of breath             |
| • Nausea and vomiting   | • Bleeding gums                   |
| • Dizziness             | • Congestion or nose bleeds       |
| • Need to urinate often | • Constipation                    |

However, your risk for secondary conditions related to your SCI may increase as you progress during pregnancy. This risk does not mean that you should not get pregnant. It simply means that you need to work with your obstetrician to take steps to prevent secondary conditions if you can and manage problems that do develop.

- You and your obstetrician may need to call on other specialists during your pregnancy. Some specialist might include a urologist, respiratory therapist, physical therapist, and occupational therapist.
- If you have had posture changes due to a curved spine, broken pelvis, or dislocated hip, there may be less room for your baby to grow to full term.

It is impossible to predict when or if secondary conditions will develop during your pregnancy. Some may occur early on in pregnancy and go away in time. Others may continue to be a problem throughout pregnancy and delivery. However, below is a breakdown of what you might expect with each trimester.

### First trimester: Week 1 through 13 is the start of many changes with your body

- **Autonomic dysreflexia (AD).** Headache and nausea are common during pregnancy, but a pounding headache and nausea may also be signs of AD. You are at risk for AD at any time if your injury level is T6 or above. You and your obstetrician should have a plan in place to manage AD if it develops.
- **Urinary Tract Infection (UTI).** You are at risk for a UTI at any time. Your obstetrician may prescribe an antibiotic to prevent an infection during your pregnancy. The UTI must be treated right away if you get one because the infection can trigger early labor as your pregnancy progresses.
- **Bowel Management.** Hormone and iron supplements are usually prescribed by your obstetrician. These medications may impact your bowel program in one of two ways.
  - Constipation - If you are constipated, you should ask your obstetrician about drinking more water, eating foods that are higher in insoluble fiber, or taking a stool softener or laxative.
  - Diarrhea - If you have diarrhea, you should ask your obstetrician about drinking more water, eating foods that are higher in soluble fiber, adjusting your dose if you are taking a stool softener or laxative until your stool is of proper consistency, and doing your bowel program more often if you are having accidents.
    - Diarrhea may even be caused by an impaction (blockage) of stool. This may be the case if you have recently had hardened, stone-like stool or little results from your last bowel movement.

### Second trimester: Week 14 through 26 is a time of weight gain because your baby is growing quickly

- **Daily activities.** Weight gain makes it hard to do some things like you did before you got pregnant. For example, transfers or pushing your wheelchair may be harder. You may get tired more quickly. You might talk with a physical or occupational therapist to find new ways to get everyday tasks done. Here are a few suggestions.
  - Make fewer transfers, use a sliding board to transfer, or get help from others.
  - Rent or buy a power wheelchair.
- **Bladder management.** A growing baby puts pressure on your bladder. Your bladder cannot hold as much urine as usual and may spasm.
  - Women who use intermittent catheterization will likely need to catheterize more often or switch to an indwelling catheter (Foley) during pregnancy.
- **Skin care.** Pressure ulcers are always a concern, but your risk for getting a pressure ulcer increases during pregnancy. Weight gain can change your posture and center of gravity to make it harder to lift your body to transfer without scraping your skin. Weight gain can also put more pressure on your bony areas when you are sitting or lying down. You might talk with a physical or occupational therapist to find new ways to get everyday tasks done. Here are a few suggestions.
  - Check your skin more often. Your obstetrician can also include skin inspections as part of your prenatal exams.
  - Do pressure relief much more often.
  - See the fact sheet, "Skin Care and Pressure Sores in Spinal Cord Injury" at <http://www.msktc.org/sci/factsheets/Skincare>.
- **Muscle spasms.** There is a chance you may have changes in muscles spasms. They may get worse if you normally have them, or you may develop muscle spasms if you normally do not have them.

- See the fact sheet, “Spasticity and Spinal Cord Injury”

### Third trimester: Week 27 through 40 is when you and your baby continue to get bigger

- **Breathing.** Your growing baby pushes on your diaphragm. This can make it harder for you to breathe, take deep breaths and cough. You might talk with a respiratory therapist to find ways to improve your breathing. Here are a few suggestions.
  - Your obstetrician may suggest breathing exercises. If your injury is high on the spine, your obstetrician may need to test how well your lungs are working.
- **Blood flow.** Pressure from the growing baby can slow the flow of blood to your legs and feet, causing them to swell.
  - Talk to your obstetrician about medicine to help keep clots from forming if you have had blood clots in the past.
  - Talk to a physical or occupational therapist to see if range-of-motion exercises or changes in positioning can improve blood flow.
  - Prop your feet up as much as possible.
  - Wear compression support hose.
  - Get extra rest.

## What happens during labor and delivery?

Women with SCI need to plan for labor and delivery in the same way as other women.

- Attend childbirth classes
- Get your nursery ready for the baby
- Know what to do when labor starts
- Get a car seat and know how to install it
- Pack your labor bag for the hospital
- Line up help for after the birth
- Stock up on diapers, wipes and other baby essentials
- Stock your fridge and pantry with groceries

Women with SCI may also have many of the common signs of labor.

- Water breaks or mucus leakage
- Feelings of fear and worry
- Diarrhea
- Unusual pain or backache
- Strong, regular contractions
- Tightening in your abdomen
- Breathing easier
- Pressure in the pelvis

You and your obstetrician need to plan for your delivery early in your pregnancy.

- You still need to pay close attention to issues with AD, UTI, bowel management, bladder management, skin care, muscle spasms, and blood flow.
- Take a tour of the labor, delivery, and patient rooms to make sure everything is fully accessible and meets your needs. Talk to hospital staff about any needs you will have.

### Labor

A full-term pregnancy is 39 or 40 weeks, but it is best to start watching for signs of labor at about 28 weeks. At that point, your obstetrician might check your cervix weekly.

- Women with paraplegia can learn how to check for labor by feeling the uterus.
- Women with tetraplegia can talk with the obstetrician about a contraction monitor that you can use at home.
- Women with a T10 level of injury or above may not feel labor pain.
- Women with injuries below T10 may feel the uterus contracting.
- Feelings of early contractions may come and go away as labor continues.
- There may be changes in breathing or spasticity.



- Although AD is more common for people with a T6 level of injury and above, AD can occur in women with any level of injury during labor.
  - The best way to prevent AD during labor is to use a continuous epidural anesthesia. This provides a long-lasting numbness during labor.

### Delivery

There is no need to have a Cesarean section (or C-section) simply because you have an SCI. In fact, most women can deliver vaginally no matter what their level of injury. Talk with your obstetrician about the type of delivery that is best for you if there are concerns.

- In some cases, a doctor may use a vacuum cup or forceps to help deliver the baby.

### After Delivery

Congratulations on your new baby! Here are a few new things to think about now.

- **Dizziness.** You may feel faint or dizzy when you sit up after delivery. Sit up slowly, wear elastic hose, or use an abdominal binder.
- **Breast feeding.** You may decide to breastfeed your baby. Most women with SCI can breastfeed, but you need to watch for problem issues.
  - You may notice more bladder spasticity as you breastfeed.
  - You may produce less milk if you have a loss of feeling in your nipples. This is because nipple contact is the trigger for breasts to produce milk.
- **Heat lamps.** Some women have an episiotomy (pronounced eh-pee-zee-ah-toe-me) during delivery to widen the opening of the vagina. Doctors often suggest the use of a heat lamp to help heal the skin near the episiotomy. Women with SCI should **not** use a heat lamp on that area because they won't be able to feel burning.

## Authorship

*Pregnancy and Women with Spinal Cord Injury* was developed by Amie B. McLain, M.D., Taylor Massengill, B.A., and Phil Klebine, M.A., in collaboration with the SCI Model Systems Knowledge Translation Center.

**Disclaimer:** This information is not meant to replace the advice of a medical professional. You should consult your health care provider regarding specific medical concerns or treatment. The contents of this fact sheet were developed under a grant from the Department of Education, NIDRR grant number H133A110004. However, those contents do not necessarily represent the policy of the Department of Education, and you should not assume endorsement by the Federal Government.

**Copyright** © 2015 Model Systems Knowledge Translation Center (MSKTC). May be reproduced and distributed freely with appropriate attribution



This fact sheet offers basic information about how the respiratory system changes after spinal cord injury, how those changes may impact health, and how you can better manage your health.

## What does the respiratory system do?

Your respiratory system (or pulmonary system) is responsible for breathing. This system enables you to inhale oxygen into your blood and exhale carbon dioxide. Your body needs the oxygen to survive, and carbon dioxide must be removed to avoid the build-up of acid in your body.

## How does the respiratory system work?

You normally breathe without thinking about it, but your brain is carefully coordinating this activity. Your brain sends signals down your spinal cord to the phrenic nerves which start at the 3rd, 4th, and 5th cervical spinal levels to contract the diaphragm.

- You can learn more about spinal nerve function in the fact sheet, "Understanding Spinal Cord Injury, Part 1 – The Body Before and After Injury."

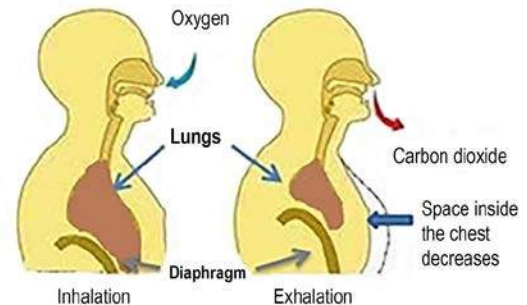

Your diaphragm is the dome-shaped muscle located under each lung (at the bottom of your chest) and is the primary muscle used for inhaling. The diaphragm moves down as it contracts.

Your lungs, rib cage and abdomen (belly) expand as air is drawn into (inhaling) your lungs through your nose and mouth. Air travels through the main airway (the trachea) and smaller airways (a series of tubes) that lead to the air sacs. Air sacs in your lungs transfer oxygen from the air to your blood. Your diaphragm moves up to where it started as it relaxes after inhalation. Your lungs, rib cage and abdomen (belly) get smaller as the muscles of inhalation relax, pushing carbon dioxide out (exhaling) through your nose and mouth.

You normally need more muscle strength, or force, to help with breathing when you exercise or cough. To provide this added assistance, particularly to help with exhaling forcefully during a cough, your brain sends signals down your spinal cord and out through the nerves coming from the thoracic portion of the spinal cord to direct your abdominal muscles (over your belly) and intercostal muscles (between the ribs).

- Coughing is important because you produce small amounts of mucus in your lungs every day. Coughing helps to remove the mucus and prevent mucus build-up that can block the airways leading to the air sacs in your lungs that absorb the oxygen from the air. When you cough, the muscles responsible for most of the force are the abdominal muscles.

## How does spinal cord injury impact the respiratory system?

Signals sent from your brain can no longer pass beyond the damage to the spinal cord, so your brain can no longer control the muscles that you would normally use for inhaling and exhaling. The extent of your muscle control loss depends on your level of injury and if there is complete or incomplete spinal cord damage.

If you have a complete **high cervical injury** that involves the spinal cord at or above the cervical 3rd, 4th, and 5th spinal nerves, you may have a loss of or weakness in diaphragm function depending on the extent of damage. You may even need a tracheostomy (an opening through the neck into the

The Spinal Cord Injury Model System is sponsored by the National Institute of Disability, Independent Living, and Rehabilitation Research, U.S. Department of Health and Human Services' Administration for Community Living. Opinions expressed in this fact sheet are not necessarily those of the granting agency. (See <http://www.msktc.org/sci/model-system-centers> for more information).

trachea, the main airway to help a person breathe) or ventilator (a machine that helps a person breathe by pushing air into the lungs). With a complete **lower cervical injury** that does not involve the cervical 3rd, 4th, and 5th spinal nerves, diaphragm function remains and usually a ventilator is not needed. In high and low complete cervical injury, you also will have a loss of control of your abdominal muscles (over your belly) and intercostal muscles (between the ribs). In **incomplete cervical injuries**, the degree of diaphragm weakness or loss of other muscle control depends on the extent of damage. If you have a **thoracic level of injury** (see image), you can lose some or all control of your abdominal muscles (over your belly) and intercostal muscles (between the ribs). The amount of loss depends on the location and extent of spinal cord damage. If you have only **lumbar** or **sacral injury levels** then your abdominal and intercostal muscles are not affected.

If you require a ventilator to breathe due to loss of diaphragm function, a pacing system to stimulate the diaphragm may be an option.

## How does loss of muscle function affect my health?

If you have a loss of respiratory muscle control, the muscles that are still functioning have to work harder to get oxygen into your blood and to get rid of the carbon dioxide. You may also have trouble coughing with enough force to get rid of mucus in your lungs. This puts you at an increased risk for respiratory health problems.

- Both a higher injury level and whether a person has complete or incomplete injury contribute to the risk of respiratory problems.
- Persons with a higher and more complete injury (for example, complete cervical) are at higher risk for respiratory problems than persons with a lower and incomplete injury.

## What health problems are common?

**Bronchitis** is an infection in the tubes that lead to the air sacs in the lungs, and **pneumonia** is an infection in the air sacs. These infections are very serious health problems because extra mucus is produced. Mucus will build up if the ability to cough is reduced due to muscle weakness or paralysis. The buildup of mucus can result in **atelectasis** ((at-uh-LEK-tuh-sis), which is a collapse of all or a portion of the lung.

Although people with cervical or thoracic injury are at highest risk for having complications, such as atelectasis with these infections, those with the highest risk are those who:

- smoke
- have chronic obstructive pulmonary disease
- have a tracheostomy
- use a ventilator

**Obstructive sleep apnea** (OSA) is another common problem. OSA occurs when a loss of muscle tone during sleep in the tongue, soft palate or other soft tissues of the throat allows the airway to collapse and obstructs the flow of air when you try to breathe in. This typically causes a drop in blood oxygen level and a rise in blood carbon dioxide level. The brain responds with a brief arousal to “jump-start” breathing. This disruption of sleep repeats throughout the night, but most people are not aware of it, because it does not cause them to fully wake up. Even though it may not wake you up, the sleep disruption can make you sleepy during the day, no matter how long you sleep at night. OSA is also associated with a number of medical problems such as:

- depression
- diabetes
- heart attacks, heart failure, and irregular heartbeat
- high blood pressure
- stroke
- death

Anyone can have OSA, but the risk is greater for people who:

- snore
- are male (the risk of OSA is also higher in post-menopausal than in pre-menopausal women)
- are overweight or obese

- drink alcohol
- take muscle relaxant medication
- have a small jaw, enlarged tonsils, or difficulty breathing through the nose

## What can I do for my respiratory health?

**Prevention** - Your first defense is to do whatever you can to prevent respiratory health problems. Here is a checklist.

- ✓ Do not smoke and stay away from secondhand smoke! Exposure to tobacco smoke is the worst thing you can do for your health. Smoking causes chronic obstructive pulmonary disease (COPD), and lung cancer, and exposure to cigarette smoke diminishes your health in many, many ways. COPD can cause the body to produce extra mucus and also causes a reduction in lung function in addition to the reduction in lung function attributable to the muscle weakness and paralysis that accompanies spinal cord injury. Plus, exposure to smoke can make worse many health problems you develop.
- ✓ Avoid the buildup of secretions in the lungs. If you have difficulty coughing and clearing secretions, a cough assist machine can be helpful in keeping your lungs clear. If you have a tracheostomy with or without a ventilator, you can also use a suction tube to keep your lungs clear. An attendant or family member can also be trained to manually assist with coughing.
- ✓ Stay hydrated. Drink plenty of water, especially if you have an infection, unless your doctor tells you something different.
- ✓ Keep a healthy weight! People who are overweight or obese typically have more problems with their lungs. They also tend to get obstructive sleep apnea. Ask your health care providers to recommend a diet if you are overweight and an exercise program to help maintain fitness. There is evidence from non-SCI populations that maintaining a high level of activity and taking part in rehabilitation programs that typically include both an aerobic and strength training component prevent future health problems. Persons with SCI who take part in an exercise program or in a sport also report a higher quality of life.
- ✓ Stay away from people who may have a cold or flu.
- ✓ Get a flu shot every year. This shot will help keep you from getting the flu but *does not* cause the flu.
- ✓ Get a pneumonia shot. Pneumonia and other pulmonary infections are among the most common causes of death following SCI, but the shot can help keep you from getting a common type of bacterial pneumonia. In persons age 65 or older, revaccination with the same shot you received before 65 is suggested. Furthermore, an additional pneumonia vaccine has been developed for persons age 65 or older that is directed at other types of this common bacteria. You should ask your health care provider about the timing of shots based on current guidelines from the US Centers for Disease Control and Prevention.
- ✓ Watch – Even with your best efforts to prevent respiratory health problems, they can still develop. The sooner you can identify any problems, the better your chance of treating them and getting better.

Signs and symptoms of a lung infection (bronchitis and pneumonia) are not always easy to identify. Mild signs and symptoms might first seem like those of a cold or flu, but they can last longer and get worse over time. Some signs and symptoms of infection may include:

- Fever and chills
- Cough or feeling the need to cough (coughing may produce thick, sticky mucus that might be clear, white, yellowish-gray or green in color, depending on the type of illness)
- Tightness in the chest
- Shortness of breath

Signs and symptoms of obstructive sleep apnea may also be mild at first and get worse over time. In fact, you might wake and fall back asleep many times throughout the night without realizing it. However, you can watch for some common signs that suggest you might have sleep apnea:

- Other people tell you that you stop breathing at night
- Loud snoring
- Restless sleep (especially if you awaken choking or gasping for air)

- Waking up with a sore and/or dry throat
- Waking with a headache
- Daytime fatigue, sleepiness, or not feeling rested after sleeping

**Visit your Healthcare Provider** – You should see your healthcare provider every year for a check-up to check for the health problems common to someone your age and with your type of injury. Persons with lung disease, such as COPD or asthma may need to see a provider more often.

- ALWAYS go see your provider if you have signs of a respiratory infection. It is important to be aggressive and avoid waiting until a mild problem becomes a much larger health problem.
- ALWAYS go see your provider if you think you have sleep apnea. Sleep apnea is a serious condition. Your provider can set you up to get a sleep study and find a treatment option that works for you.
- Ask your provider if you should get a lung function test to see how well your lungs function. This is especially important if you have ever smoked, have COPD, or have asthma. If you have problems breathing, you may need medication that opens the airways to help the lungs work, helps you breathe easier, and makes it easier to do your day-to-day activities.

## Authorship

*Respiratory Health and Spinal Cord Injury* was developed by Eric Garshick, MD, MOH, Phil Klebine, MA, Daniel J. Gottlieb, MD, MPH, and Anthony Chiodo, MD in collaboration with the Model Systems Knowledge Translation Center. Dr. Garshick and Dr. Gottlieb are members of the Pulmonary, Allergy, Sleep, and Critical Care Medicine Section, VA Boston Healthcare System, Department of Veterans Affairs, Boston, MA.

**Source:** Our health information content is based on research evidence and/or professional consensus and has been reviewed and approved by an editorial team of experts from the Spinal Cord Injury Model Systems.

**Disclaimer:** This information is not meant to replace the advice of a medical professional. You should consult your health care provider regarding specific medical concerns or treatment. The contents of this fact sheet were developed under a grant from the National Institute on Disability, Independent Living, and Rehabilitation Research (NIDILRR grant number 90DP0012-01-00). The contents of this fact sheet do not necessarily represent the policy of Department of Health and Human Services, and you should not assume endorsement by the Federal Government.

**Copyright** © 2015 Model Systems Knowledge Translation Center (MSKTC). May be reproduced and distributed freely with appropriate attribution



It is natural to have questions about relationships, sex, and having children after spinal cord injury. This fact sheet will help you better understand your body and answer some common questions after injury.

## What is sexuality?

Your sexuality is what guides your natural desire to bond with others through love, affection, and intimacy. Here are a few ways you might express your sexuality.

- **Emotional connections**—feeling close to someone
- **Physical contact**—acts of touching such as holding hands, hugging, kissing, cuddling, and sexual activity.
- **Sexual identity**—how you think and feel about yourself and your desires for the opposite sex, same sex, or both.
- **Gender identity**—the gender you feel you are “inside” (your body may or may not match the gender you feel you are).

## How does spinal cord injury impact sexuality?

Loss of muscle movement, sense of touch, and sexual reflexes often occurs after spinal cord injury (SCI). How this loss effects arousal, orgasm, and fertility depends on your level of injury and whether your injury is complete or incomplete.

- To learn more on the nervous system and about complete and incomplete injuries, please see [“Understanding Spinal Cord Injury: Part 1—The Body Before and After Injury”](http://www.msctc.org/lib/docs/Factsheets/SCI_Understand_Spin_Crd_Inj_Prt1.pdf) at [http://www.msctc.org/lib/docs/Factsheets/SCI\\_Understand\\_Spin\\_Crd\\_Inj\\_Prt1.pdf](http://www.msctc.org/lib/docs/Factsheets/SCI_Understand_Spin_Crd_Inj_Prt1.pdf).

You may not have a strong desire for sex when first injured, but your desire will likely increase over time as you learn to manage self-care and understand your body after injury. If not, talk to your doctor. It is possible your medications are interfering with sexual desire. Changing medications may help.

SCI may also impact how you think and feel about yourself. Some people may not feel desirable after SCI. However, loss of movement or sensation does not change the fact that you are a desirable sexual being. You are more likely to feel desirable and want to fully express your sexuality if you understand your body and feel comfortable with yourself and your personal identity. This fact sheet will help you.

## Is dating different after injury?

Here are a few ways dating is usually the same as before your injury.

- You increase your opportunities to meet people by making yourself available to meet them. This might be online dating or getting out and meeting people.
- You have to ask for a date to know if he or she will go out on a date with you.
- It is just as important after injury as it was before your injury to practice safe sex to prevent pregnancy and contracting sexually transmitted infections/diseases.

Here are a few ways dating may be different.

- You will probably be asked about your injury and how you manage daily activities. Be ready to respond in a way that is comfortable for you.
- You may need to balance your dating schedule with a caregiver’s schedule.
- You may be living with a family member or someone else after your injury. If so, you may need to talk with them about setting up guidelines for bringing a date home, privacy, and personal space.

The contents of this fact sheet are based on research evidence and/or professional consensus and has been reviewed and approved by an editorial team of experts from [the Spinal Cord Injury Model Systems, which is sponsored by the National Institute on Disability, Independent Living, and Rehabilitation Research](http://www.msctc.org/sci/model-system-centers) (See <http://www.msctc.org/sci/model-system-centers> for more information).

## Understanding Sexual Arousal

### What is sexual arousal?

Sexual arousal is the body's response to your desire for sex. This includes an increase in heart rate, blood pressure, and breathing rate, and can include an increase in blood flow to the genitals to ready your body for sex.

- Women have an increase in vaginal lubrication to ready the vagina for easier, safer penetration.
- Men get an erection.

People without SCI are usually aroused through two pathways.

- **Reflex pathway**—Arousal that occurs in response to sensual touching.
- **Psychogenic pathway**—Arousal that occurs from psychological sexual sensations such as sexual thoughts, sights, smells, or sounds that turn you on sexually.

### Sexual arousal after injury

One or both of your pathways for arousal may be blocked.

- Most people with SCI can be aroused by sensual touching. Try stimulating your body in sexual ways to find out if you become aroused. Does masturbation feel good? Does oral sex? You might also enjoy touching in areas like your neck, ears, nipples, and inner thighs.
- Some people with SCI, mainly those with an incomplete injury, may be aroused by psychological sexual sensations.
  - The more sensation you have in the area between your belly button and front pant pocket areas (upper outer thigh), the more likely you are to be aroused in your genitals by sexual thoughts, sights, smells, or sounds.

### What can I do if I cannot get aroused after injury?

Talk to your doctor. Changing your medications may help with the problem. Often times, spasticity medications, pain medications, or antidepressants are contributing factors. If not, here are other actions that might help address the problem.

- Women—having your partner perform oral sex may help increase vaginal lubrication enough for penetration. Using a water-based lubricant is another option.
- Men—most men can get an erection with sensual touching after you take a medication like sildenafil, tadalafil or vardenafil. If cannot, talk to your health professional about other options, which might include a constricting ring, vacuum suction device, injection of medications into the penis, or a surgically implanted penile prosthesis.

## Understanding Orgasm and SCI

### What is orgasm?

An orgasm is a reflex response of the nervous system that feels good and relaxes you.

### Orgasm after injury

Most people with SCI can still have orgasms. Here are some important facts to know.

- Stimulation to the genitals is usually a good way to achieve orgasm.
- Sensual touching in the area where your sensation changes (at your injury level) may help to achieve orgasm.
- Achieving an orgasm generally takes longer and may feel “different” than it did before your injury.
- Women—using a vibrator is helpful for achieving an orgasm.
- Men—often have orgasms where the semen goes back into the bladder instead of coming out through the penis (also known as retrograde ejaculation).
- Orgasms are often followed by a decrease in spasticity.

### What can I do if I cannot have an orgasm after injury?

Remember, sexual activity can be great fun with or without orgasm, but here are some potential options.

- It is important that you and your partner not give up too soon. Sometimes it just takes time and practice.



- Try masturbating with or without a vibrator.
  - If your injury is at or above T6, you should be careful and watch out for headaches and other signs and symptom of Autonomic Dysreflexia (AD). If that happens, stop activity, check your blood pressure, and ask your doctor to review your medications to see if they can be adjusted. For more information about AD, please read “Autonomic Dysreflexia” (Coming Soon).
- Talk to your doctor about using medical devices.
  - Men—a high amplitude vibrator held against the head of the penis may stimulate ejaculation.
  - Women—a gentle suction device can help increase the ability of the clitoris to respond so you can achieve orgasm.

## Understanding Fertility and SCI

### What is fertility?

Women become pregnant when sperm, which is in semen, fertilizes an egg.

### Can I have children after injury?

Yes! You decide to have children in much the same way as anyone else. You consider the demands and challenges of parenting and how you might manage them. Here are other facts to consider when deciding whether or not you want to have children.

- Men and women of all levels of injury have had children after their injury. You can too if you choose.
- The positive aspects of parenting usually outweigh the difficulties.
- <http://www.lookingglass.org/> and <http://www.disabledparents.net/> are good online resources for people with SCI who are or want to be parents.
- You need to practice safe sex if you want to prevent pregnancy
  - Condoms are considered the best choice for both men and women with SCI.
  - Women—talk to your doctor if you are interested in birth control options other than condoms.
    - Intrauterine devices and diaphragms are generally not ideal if you have problems with sensation and insertion.
    - The pill is not usually recommended because it increases your risk for developing a blood clot (deep vein thrombosis).

### Do women have problems getting pregnant after injury?

There is usually a brief pause in your period when you are first injured. You can naturally become pregnant, carry, and deliver a baby once your period returns. Contact your doctor if your period does not return with a few months after injury.

You are at higher risk for common secondary complications of SCI during pregnancy, but you can prevent problems or manage problems if they develop. It is best that you have an obstetrician who understands, or is willing to learn, the facts about pregnancy, labor and delivery for women with SCI.

- For more information on pregnancy, labor and delivery, please read [“Pregnancy and Women with Spinal Cord Injury”](http://www.msctc.org/sci/factsheets/Pregnancy) at <http://www.msctc.org/sci/factsheets/Pregnancy>.

### Do men have problems getting their partner pregnant after injury?

Some men with SCI can get their partners pregnant through sexual intercourse, but many men cannot.

- May be unable to ejaculate into the vagina during intercourse.
- Sperm may be unable to swim to fertilize the egg (also known as poor sperm motility).

Urologists who are experienced in SCI can offer treatment options.

- In-Home Insemination—if a high amplitude vibrator can stimulate ejaculation, the semen can be collected in a clean cup. The semen can be drawn from the cup into a syringe. The syringe can be inserted into your partner’s vagina, and the semen is slowly injected.
  - Retrograde ejaculation may be treated with medications.
  - Vibratory stimulation may cause Autonomic Dysreflexia if your injury level is T6 or above.
- Medically assisted procedures—doctors may use methods such as electroejaculation, intrauterine insemination, or in vitro fertilization.



## How can I help my partner adjust to changes with my body after injury?

Here are some tips for both you *and* your partner.

- Understand your body. This fact sheet is only a starting point to begin to understand how your body might change after injury. Your body is unique, so your issues are unique, too. It can take time to understand how your body works and manage problem issues.
- Take the time to figure out what each of you finds pleasing and exciting. What you did before your injury may work for you. If not, you and your partner can be creative and open to exploring new ways to find sexual satisfaction.
- Have fun. Using humor and being playful are keys to having a more interesting, enjoyable and mutually pleasurable experience.
- Keep an open mind along with an honest and open line of communication. Below are some helpful suggestions:
  - **Know what you want to communicate.** This involves self-awareness and possibly self-exploration to get a clear sense of what you want or need sexually.
  - **Communicate your needs to each other.** Talking about sex can be difficult, so you will want to communicate in a way that makes both you and your partner feel comfortable. Some couples find it helpful to write down their needs. The goal is to talk about any issues or concerns and work together to solve problems and resolve concerns.
  - **Listen to each other.** Healthy communication requires give and take. Listen and be open to your partner's response, just as you would like your partner to do for you. Listening to your partner can help resolve issues in a way that satisfies both partners. This includes paying attention to body language.
  - **Be flexible.** Couples commonly need time to get comfortable with each other. You will likely experience a few setbacks. For example, there may be issues with bowel, bladder, and spasticity. However, you and your partner should be able to manage issues as you continue to communicate, listen, and remain flexible.

## How do I keep the romance alive if my partner is also my caregiver?

Do everything you can to keep the role of the caregiver separate from that of a romantic partner. This will better allow you to enjoy each other when you are feeling romantic. Here are some tips.

- Be as independent as possible. Learn to do as much as you can with your self-care and other daily living activities. This will limit the amount of help you need from a caregiver.
- Have set times when caregiving tasks are needed and set other times, like a date night, when there is romance without caregiving. Keeping these roles separate will help you to avoid confusing and blurring the two roles.
- Hire a personal care attendant (PCA) to take on some caregiving tasks if you can. You may qualify for programs that can help if you cannot pay for one. Some agencies that you might contact are your state's Vocational Rehabilitation Services, your local Independent Living Center, or the Department of Veteran's Affairs if you are a veteran.

## Who can I talk to if I have problems or questions?

Most problems have a solution, and professionals who know about sexuality *and* issues of SCI are your best option to find solutions. They can provide you with accurate information, treat you with respect, and ensure confidentiality answering your questions.

- Talk to a doctor or nurse about medical needs.
- An occupational therapist or physical therapist can be helpful in suggesting equipment needs.
- An experienced counselor, psychologist, social worker, or sex therapist can usually help individuals and couples work through relationship problems and identify other helpful resources.

## Authorship

*Sexuality & Sexual Functioning After Spinal Cord Injury* was developed by Marcalee Alexander, M.D., Trisha Hicks, MSW, LSW, M.Ed., Mindy Aisen, M.D., and Phil Klebine, M.A., in collaboration with the SCI Model Systems Knowledge Translation Center.

**Disclaimer:** This information is not meant to replace the advice of a medical professional. You should consult your health care provider regarding specific medical concerns or treatment. The contents of this fact sheet were developed under a grant from the National Institute on Disability, Independent Living, and Rehabilitation Research (NIDILRR grant number 90DP0012-01-00). NIDILRR is a Center within the Administration for Community Living (ACL), Department of Health and Human Services (HHS). The contents of this fact sheet do not necessarily represent the policy of NIDILRR, ACL, HHS, and you should not assume endorsement by the Federal Government.

**Copyright** © 2015 Model Systems Knowledge Translation Center (MSKTC). May be reproduced and distributed freely with appropriate attribution



# Surgical Alternatives for Bladder Management Following SCI



January 2015

SCI Fact Sheet

This fact sheet tells you about two types of surgery that use your intestine to manage bladder problems caused by your injury. Surgery is used only when other bladder management strategies have not worked.

## What you need to know

- Your ability to control urine release may be limited because of injury. You may not be able to stop urine from flowing out of your body, or you may not be able to release urine from your body.
- The inability to control the release of urine is called “urinary incontinence” (pronounced in-KAHN-ten-ens).
- The inability to release urine is called “urinary retention.”
- Surgery can sometimes be used to help manage these problems if nonsurgical bladder management approaches do not work. Surgeries that use a part of your intestines will be discussed.
- All surgery comes with risks of bleeding, serious infection, and other side effects.
- More than one surgery may be needed to manage your bladder function.
- Surgery using the intestine to enlarge the bladder or as a substitute for the bladder is very rarely used in adults with SCI. It is more commonly used in children with spina bifida who have a very damaged bladder or in adults who have their bladders removed because of bladder cancer.
- Because surgery using the intestine is used so rarely in adults with SCI, we do not have enough information to discuss risks, benefits, alternatives, and the specific impact on lifestyle in adults with SCI. Therefore, it is very important that you speak with a surgeon who is very experienced in this type of surgery and a rehab doctor to discuss how surgery may help in your specific case.
- To learn about the problems caused by your injury and the strategies used to help you manage bladder problems (see [MSKTC factsheet entitled Bladder Management Options Following Spinal Cord Injury](http://www.msktc.org/sci/factsheets/bladderhealth) <http://www.msktc.org/sci/factsheets/bladderhealth>)

## Understanding your urinary tract

Waste from your body is removed from your blood stream by your kidneys and becomes urine. Normally, urine passes down the ureters into your bladder (a small pouch that holds your urine located in the lower middle part of your abdomen below your beltline). A sphincter (pronounced SFINK-ter) made of muscle circles the opening of your bladder, where urine flows out of your bladder. The sphincter acts like a valve that opens and closes to control when the urine comes out of your body. When you urinate, your bladder squeezes and your sphincter relaxes. Urine passes from the bladder through the urethra (pronounced yur-EETH-rah) and out of your body. In women, the urethral opening is right above the vagina. In men, the urethral opening is at the tip of the penis. Surgery may involve any of these parts of your urinary tract as well as your intestines or your stomach.

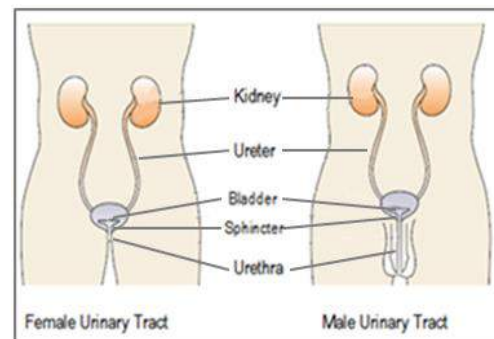

The Spinal Cord Injury Model System is sponsored by the National Institute of Disability, Independent Living, and Rehabilitation Research, U.S. Department of Health and Human Services' Administration for Community Living. Opinions expressed in this fact sheet are not necessarily those of the granting agency. (See <http://www.msktc.org/sci/model-system-centers> for more information).

## Why do I need surgery that uses part of my intestine?

Sometimes, your injury or other health issues may limit your ability to use traditional bladder management methods, or the traditional methods are not working as well as they should. The goal of surgery, like other bladder management strategies, is to enable you to remove urine from your body and keep your kidneys healthy and maintain a life style that is best for you. Some of the reasons you might need surgery are:

- You would like to perform intermittent catheterization but this is not practical because you have a very small overactive bladder (a bladder that squeezes with only a small amount of urine in the bladder) despite medications.
- Your bladder has lost its ability to stretch and therefore develops a high pressure when it fills up with urine, causing back pressure and damage to your kidneys despite medications.
- You have a problem that cannot be treated with medications, such as an over-stretched or damaged urethra, which is causing constant urinary leakage.

## Will surgery cure my bladder problems?

Surgery cannot make your bladder work normally, but it can:

- Help you be able to use a bladder management strategy such as intermittent catheterization.
- Create new ways for you to release urine from your body.

## What are some surgical procedures that use part of my intestine?

There are a number of surgical procedures and variations involving the use of your intestine to help with your bladder problems. The type of surgical procedure that may help you depends on the problem you are having with your bladder and what type of bladder management you would like to have. Below are two common types of surgical procedures.

### Bladder Augmentation Surgery

Bladder augmentation (pronounced awg-men-TAY-shun) surgery is for people who are having kidney damage because they have a small bladder with forceful squeezing that causes back pressure to the kidneys. It is also helpful for people who want to perform intermittent catheterization but have a small, overactive bladder despite medications. You should not have this surgery if you are unable or unwilling to perform intermittent catheterization or if you have problems with your bowels such as inflammatory bowel disease. The surgery increases your bladder size so that it has less forceful squeezes (more relaxed), enabling it to hold more urine at one time. It does not improve the way your bladder functions. Having a larger, more relaxed bladder makes it easier for urine to drain from your kidneys into your bladder and more practical to perform intermittent catheterization (for a description of intermittent catheterization, see [MSKTC factsheet entitled Bladder Management Options Following Spinal Cord Injury](http://www.msktc.org/sci/factsheets/bladderhealth) <http://www.msktc.org/sci/factsheets/bladderhealth>).

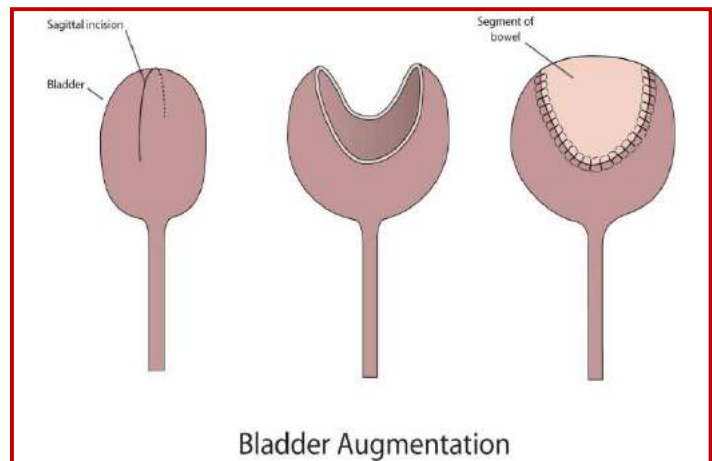

During the surgery:

A surgeon removes a small part of your intestine and then sews the piece onto your bladder, much like sewing the top of a clamshell (intestine) onto the bottom of a clamshell (bladder) to make the bladder larger. If you have a weak sphincter, you may start to leak urine from your urethra. In this case you may need treatment of your sphincter to make it stronger. You and your doctor may consider additional surgical treatment to tighten your sphincter or use a urinary diversion as discussed below.

## Urinary Diversion

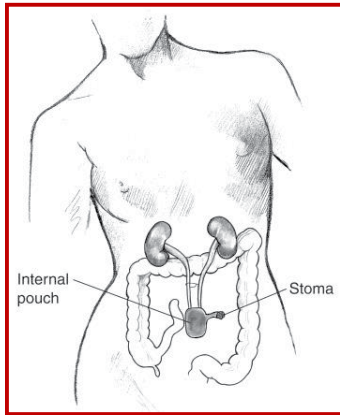

Urinary diversion redirects the urine flow from your bladder to a pouch of intestine that has been made to hold your urine. This surgery is for people who have a very small, damaged bladder that cannot be improved with a bladder augmentation; a bladder that has to be removed for some reason such as cancer; or a very damaged urethra that makes it difficult to pass a catheter into your bladder. In this surgery:

- A surgeon creates an artificial bladder using parts of your stomach or intestine.
- The surgeon then sews your ureters into the new pouch.
- Another piece of intestine is used to make a tube from the pouch to an opening on your abdomen (this opening is called a “stoma” (pronounced STOH-mah)).
- Sometimes the pouch can be sewn directly onto your urethra, so you can drain your bladder through your urethra rather than a bag or catheter.

There are two other types of surgery:

### Incontinent Urinary Diversion

This form of urinary diversion is called “incontinent” because there is nothing holding the urine in the new bladder. Urine drains out of the opening in your abdomen (stoma) as soon as it is made. A bag outside of your body is attached to the stoma to collect this urine. You can empty the bag whenever it is full.

### Continent Urinary Diversion

This form of urinary diversion is called “continent” because the stoma is made with a small fold that keeps the urine from draining out on its own. The urine is held in the new bladder and removed by passing a catheter down through the stoma into the new bladder.

## What are the risks of surgery?

All surgery comes with risks. “Risk” means that these problems **could** happen; it does not mean that they **will** happen. Talk with your surgeon or doctor about your overall health and what may be a higher risk for you. There are two types of risks, short-term risks that occur right after surgery and long-term risks (late complications) that can occur later on. Long-term complications take time to develop and may occur several weeks, months, or even years after your surgery.

### Some of the more common possible short-term surgical risks include:

- You could have an allergic reaction to or other problems with the anesthesia (pronounced an-es-THEE-zha), the medicine used to put you to sleep during surgery.
- You could develop pneumonia after surgery.
- The wound where the surgery is performed could become infected.
- Your intestines could take a long time to “wake up” after surgery, causing discomfort, vomiting, and constipation.
- You could develop a deep venous thrombosis or pulmonary embolism.
- You could have a urine leak or blockage or other problem from the intestine where you had your surgery, which could require another operation

**Some of the more common possible late risks/complications from bladder augmentation or urinary diversion surgery include:**

- Increased risk of kidney or bladder stones.
- A tear/rupture of your new intestine pouch due to over-stretching (rare).
- Loose stools or diarrhea, depending on the part and amount of your intestine that is removed.
- Increased risk of cancer at the area around the bladder and intestine (rare).
- Bowel obstruction (blockage) caused by part of your intestine getting caught in some of the scar tissue from your surgery. This is often a surgical emergency requiring surgery to correct the blockage to prevent your intestine from rupturing and causing you to become extremely sick.
- Mucus in the urine because the piece of intestine attached to the bladder may create a lot of mucus. Sometimes this can clog the catheter you are using to drain your bladder or make it difficult to know for sure if you might have a bladder infection.
- There are also specific metabolic changes and other possible complications, depending on which part of your intestine (or your stomach) is used. Your surgeon will be able to tell you more about these possible risks.

**Some of the more common possible late complications from urinary diversions (only) include:**

- Scar tissue around the tube from the kidney, which squeezes the tube partially shut.
- Narrowing of the skin around the stoma can make it difficult for urine to drain out of the intestinal pouch or pass a catheter down into the intestine pouch to drain the urine.
- Parastomal hernia. The piece of intestine that goes from the pouch up to the skin starts to push up and around the opening of the skin (stoma).

For more details on bladder management including surgical management see: Bladder management for adults with spinal cord injury: a clinical practice guideline for health-care providers. Consortium for Spinal Cord Medicine. J Spinal Cord Med. 2006;29(5):527-73.

**Ask your doctor about your level of risk for any of these complications, and what can be done if any of them occur.**

## Authorship

Surgical Alternatives for Bladder Management After SCI was developed by Todd A. Linsenmeyer, M.D., and Steven Kirshblum, M.D., in collaboration with the Model Systems Knowledge Translation Center.

**Source:** Our health information content is based on research evidence and/or professional consensus and has been reviewed and approved by an editorial team of experts from the Spinal Cord Injury Model Systems.

**Disclaimer:** This information is not meant to replace the advice of a medical professional. You should consult your health care provider regarding specific medical concerns or treatment. The contents of this fact sheet were developed under a grant from the National Institute on Disability, Independent Living, and Rehabilitation Research (NIDILRR grant number 90DP0012-01-00). The contents of this fact sheet do not necessarily represent the policy of Department of Health and Human Services, and you should not assume endorsement by the Federal Government.

**Copyright** © 2015 Model Systems Knowledge Translation Center (MSKTC). May be reproduced and distributed freely with appropriate attribution. Prior permission must be obtained for inclusion in fee-based materials.





This fact sheet is intended to be a starting point for understanding the normal functions of the spinal cord and how those functions might change after spinal cord injury (SCI). The impact of injury is different for everyone, so it is impossible to answer every question of interest. However, this fact sheet will answer a few common questions.

## What is the spine?

The spine (also known as the “backbone”) is the connected column of bones running from your head to your lower back. A single bone is called a “vertebra” (pronounced VER-teh-brah), and multiple bones are called “vertebrae” (pronounced VER-teh-bray). The figure shows the spine and vertebrae.

The figure also shows the five sections of the spine. Each section is made up of a group of vertebrae.

- At the top of the spine, at your neck, is the cervical (C) section. There are 7 vertebrae in this section. Each vertebra is numbered top to bottom from C1 to C7.
- Below the cervical section is the thoracic (T) section. There are 12 vertebrae here. Each is numbered from T1 to T12.
- The lumbar (L) section follows. There are 5 vertebrae here. Each is numbered from L1 to L5.
- The next section is the Sacral (S) section. This is also called the “sacrum.” Here the 5 vertebrae are fused together as one bone.
- At the bottom of the spine, 3 to 5 vertebrae are fused together as one bone segment in the coccygeal (Cx) section. This is also called the “tailbone.”

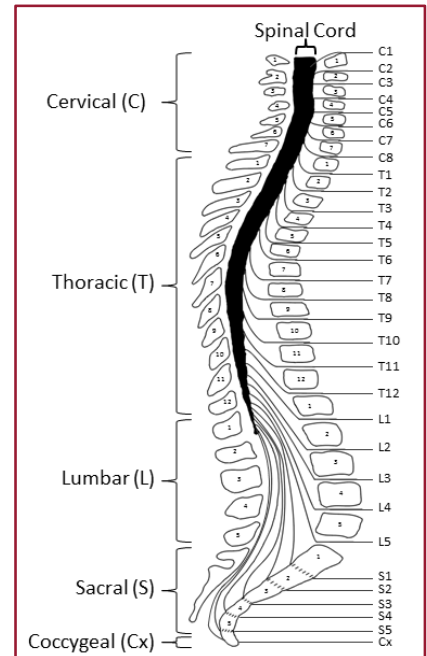

\*The end of the spinal cord is the conus medullaris. Below the conus medullaris, the spinal nerve roots look like a horse’s tail, which is why these nerves are called the cauda equina, the Latin term for “horse’s tail.”

## What is the spinal cord?

The spine surrounds and protects the spinal cord, which is a fragile, dense bundle of nerves running from the base of your brain down through the open space in the vertebrae (also known as the spinal canal). The spinal cord ends near the L1 vertebra, but spinal nerve “roots” continue to run from the end of the spinal cord to the lower spinal canal.\*

## What does the spinal cord do?

Your brain and spinal cord are part of your body’s nervous system. The brain is the command center for your body. The spinal cord is the nerve pathway that allows your brain and body to communicate.

Spinal nerves are another part of this message system. There are 31 pairs of spinal nerves branching from the left and right sides of the spinal cord. These nerve pairs are numbered to match the number of the vertebra nearest to where they leave the spine. For example, the T2 spinal nerves exit the spinal column below the T2 vertebra. When all the nerve pairs exit the spinal column, they begin to branch off into the many nerves that spread like a spider web to all parts of your body.

The Spinal Cord Injury Model System is sponsored by the National Institute on Disability and Rehabilitation Research, Office of Special Education and Rehabilitative Services, U.S. Department of Education. (See <http://www.msctc.org/sci/model-system-centers> for more information).

When your nervous system is working properly, it carries vital messages to and from your brain and body. The nervous system is a complex process, but the flow of messages basically control three important functions:

1. *Motor function* is your ability to control the movement of your muscles.
2. *Sensory function* is the sensation of touch, your ability to “feel” things.
3. *Autonomic function* refers to the reflex actions that your brain controls without you having to think about it. Your blood pressure is one example.

## What is a spinal cord injury?

A spinal cord injury (SCI) is damage to the spinal cord or the spinal nerve roots within the spinal canal and resulting in temporary or permanent loss of movement and/or feeling.

## What are common causes of spinal cord injury?

According to the National SCI Statistical Center, motor vehicle crashes are the most common cause of SCI. Accidental falls are the next most common cause of SCI, followed by acts of violence (mostly gunshot wounds).

## What is “level of injury?”

This refers to your neurological level of injury. It is the lowest point on your body where you have normal muscle movement and feeling after SCI. Medical professionals find this point using the International Standards for Neurological Classification of SCI. The exam has two parts.

- Muscle strength tests are used to find the lowest point on your body where you have normal movement.
- “Pin-prick” and “light-touch” skin tests are used to find the lowest point on your body where you have normal feeling.

## What is the difference between “complete” and “incomplete” injury?

When medical professionals find your level of injury, they also use the ASIA Impairment Scale (AIS) to grade the severity of your injury. The difference between complete and incomplete is whether or not you have any feeling in your anal area or you can tighten your anus.

- Complete injury – You do not have feeling in your anal area and cannot tighten your anus. This is graded as AIS A. Although your injury level is the lowest point where you have “normal” movement and feeling, you may or may not still have some feeling or movement below your injury level. It may extend one level or as much as a few levels below your injury level. This is your Zone of Partial Preservation.
- Incomplete injury – You have feeling in your anal area or can tighten your anus. Your grade depends on how much feeling or movement you have below your injury level. AIS B means you have feeling but not muscle movement below your injury level. AIS C means you have weak muscle movement below your injury level. AIS D means you have strong muscle movement below your injury level.

## Why do I need to know the difference between complete and incomplete?

There is no sure way to tell if function will return after injury, but your potential for recovery is based on whether the severity of your injury is complete or incomplete [see “Understanding of Spinal Cord Injury: Part 2—Recovery and Rehabilitation”].

## What is paralysis?

“Paralysis” is a word used to describe a loss in the ability to control muscle movement, but it often includes the loss of other functions, too. The degree of paralysis is greater for higher levels of injury compared to lower levels of injury. Examples:

- A person with a complete C4 level of injury is paralyzed from the shoulders down.
- A person with a complete T12 level of injury is paralyzed from the waist down.

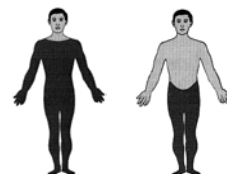

## What is tetraplegia?

“Tetraplegia” (pronounced tet-ra-plē-jah), also known as “Quadriplegia” (pronounced kwā-drē-plē-jah) is paralysis caused by a cervical injury. It includes some degree of paralysis in both the upper body (shoulders, arms, hands, and fingers) and lower body (chest, legs, feet, and toe).

## What is paraplegia?

“Paraplegia” (pronounced para-plē-jah) describes paralysis that results from a thoracic, lumbar, or sacral injury. It includes some degree of paralysis in the lower body (chest, legs, feet, and toes).

## Authorship

*“Understanding Spinal Cord Injury: Part 1 – The Body Before and After Injury”* was developed by was developed by Phil Klebine, M.A., in collaboration with the Model Systems Knowledge Translation Center.

**Source:** Our health information content is based on research evidence and/or professional consensus and has been reviewed and approved by an editoria team of experts from the Burn Injury Model Systems.

**Disclaimer:** This information is not meant to replace the advice of a medical professional. You should consult your health care provider regarding specific medical concerns or treatment. The contents of this fact sheet were developed under a grant from the Department of Education, NIDRR grant number H133A110004. However, those contents do not necessarily represent the policy of the Department of Education, and you should not assume endorsement by the Federal Government.

**Copyright © 2015** Model Systems Knowledge Translation Center (MSKTC). May be reproduced and distributed freely with appropriate attribution. Prior permission must be obtained for inclusion in fee-based materials.

**More in the “Understanding Spinal Cord Injury” series:** Part 2—Recovery and Rehabilitation





This fact sheet is the second in a two-part series in understanding spinal cord injury (SCI). Part one, [The Body Before and After Injury](#), contains terms and information that are discussed in this fact sheet.

### Can paralysis caused by spinal cord injury be reversed?

Everyone wants to know if there is a “cure” for spinal cord injury (SCI). There continues to be significant progress made toward this goal, but, despite any claim that there is a cure, there is currently no proven way to reverse paralysis.

### Will I gain any improvements?

There are three areas for potential improvement after SCI.

1. **Severity of Injury:** At the time of your injury, your injury is graded as either complete or incomplete. Your grade may change. For example, you may be first classified as AIS C and improve to AIS D.
2. **Levels of injury:** At the time of your injury, you are diagnosed with a neurological level of injury. You may regain levels of injury over time. For example, you may be first classified with a C4 level of injury and improve to a C5 level. This means you gain control of more muscle movement.
3. **Functional abilities:** These are the activities you are capable of doing as you regain muscle strength and learn to use those muscles after injury. Pushing a wheelchair is one example.

### How much improvement will I gain?

There is almost always hope for at least some improvement after SCI, but there are no guarantees. You have to wait to see what happens in the months after your injury. Here are a few rules of thumb.

- People with a complete injury often regain 1 or 2 levels of injury. This means you often regain control of 1 or 2 levels of muscle movement.
- People with an incomplete injury are more likely than people with a complete injury to regain control of more muscle movement, but there is no way to know how much, if any, will return.
- As long as you are seeing some improvement, like regaining muscle movement, your chances for improvement are better.
- The longer you go without seeing improvement, your chances for improvement are lower.

### What is Rehabilitation?

Your body drastically changes after paralysis. You have medical needs that must be managed. You lose muscle movement and feeling. Plus, you probably have muscle weakness and fatigue after injury in the muscles that you can move. Simply put, you may not be able to do some daily living activities in the same way you did before your injury.

Rehabilitation (rehab) is a medical service that can help you reach your full potential after injury. Every injury is different, so rehab is tailored to each person’s needs. Skilled specialists provide the necessary services to help you make the most of your abilities.

- **Physiatrists** (pronounced fiz-EYE-ah-trists) are rehab doctors who lead your treatment team and manage your medical care.
- **Psychologists** develop and apply treatment strategies in counseling to help you through your adjustment to life after injury.
- **Nurses** usually carry out orders from your doctor, and they often provide the essential education you need on how to manage issues like bowel and bladder management.

The Spinal Cord Injury Model System is sponsored by the National Institute on Disability and Rehabilitation Research, Office of Special Education and Rehabilitative Services, U.S. Department of Education. (See <http://www.msctc.org/sci/model-system-centers> for more information).

- Physical therapists use a wide variety of techniques to help you regain the strength and stamina to maximize your physical abilities.
- Occupational therapists use a wide variety of techniques to help you increase and maintain your independence in carrying out your daily living activities.
- Speech-language pathologists (speech therapists) treat any issues that may develop with swallowing or speaking.
- Social workers link you and your family to information and resources that help ease your transition from in-patient rehabilitation to home and community living.

## What is my role in rehab?

You have to put all of your effort into rehab to get the most out of it. You will work with your rehab team to set goals that are a realistic expectation of what you should be able to do with the muscle movement you have after injury. To reach your goals, you have to work as hard as you can with your rehab team to help you get stronger and learn the skills you need to manage daily activities and be independent. Some common goals include using a wheelchair, transferring, driving a car, bathing, eating, and dressing.

Also, learn as much as you can about how to take care of yourself. Learn how to manage your daily concerns, such as bladder and bowel. Learn how to best prevent health problems like pressure ulcers, urinary tract infections, and pneumonia. Learn what you should do if you develop pain, autonomic dysreflexia, depression, or other medical problems.

## What advice can be offered from other people with SCI about rehab?

People who have been injured and gone through rehab understand what you and your family are experiencing. They have been where you are now, and they can offer some valuable suggestions to help guide you during rehab. They offer the following advice.

- Trust your rehab team. Rehab professionals are very knowledgeable, and it is in your best interest to follow their advice in setting and reaching your goals. They can also advise you on how to best avoid many of the common setbacks people experience during rehab. For example, pressure ulcers can severely limit your ability to participate in rehab, but most pressure ulcers can be prevented if you do your weight shifts (also known as a pressure relief) as directed by your rehab team.
- Remember that *who* you are does not change after injury. You have the love and support of your family, friends, and others in your community. They can be a valuable support network in helping you reach your goals.
- Approach rehab with a balanced mindset. Everyone hopes they will regain all of their lost movement and feeling. However, the reality is that people are more likely to regain some, but not all, movement and feeling. This makes it very important that you participate in rehab to learn the skills necessary to have the healthiest and happiest life after SCI. Attending education classes will help you learn about SCI and how to take care of yourself. If you do regain everything, you have lost nothing in the process of learning those skills. If you do not regain everything, you will have the valuable knowledge and skills you need for everyday living.
- Be patient. SCI is a traumatic event that tears your life apart in an instant, and it takes time to rebuild your life after injury. Your body will need time to heal from the trauma of your injury. You will need time to regain the strength and stamina to reach your goals. However, you can do it in time.
- You will have bad days. It is only natural to feel sad, angry, or afraid at times. There may be times when it is hard to imagine how you can ever be happy after injury. However, most people do find happiness over time as they begin to realize they can live an active, healthy life.
- Take advantage of peer support. Your rehab team can likely arrange for you to talk with others who have SCI. They have been where you are and learned how to manage day-to-day activities. They can be a valuable source of information. There are also some online support networks. Here are a couple of recommended sites that have a focus in peer support.
  - [www.spinalcord.org](http://www.spinalcord.org) provides information and resources to meet the needs of people with SCI and their families and friends.
  - [www.facingdisability.com](http://www.facingdisability.com) is designed to provide Internet-based information and support for people with SCI and their families. The website has more than 1,000 videos of family members answering real-life questions about how they cope with SCI.
- Ask questions. You will probably have many questions. If you have questions, ask your rehab team. Most questions can be answered, but there may be some questions that cannot be answered. When it comes to regaining movement after injury, for example, sometimes it just takes time to see what happens.

## What are my functional goals?

There is a chart on the following pages that outlines common functional goals. These goals are daily activities that most people can manage with the control of muscle movement that they have with a complete injury. You may be able to do additional activities if you have an incomplete injury or if you regain control of more muscle movement. You will work with your rehab team to set your goals and find ways you can reach your goals. Below is a step-by-step guide to using the chart.

1. Find your level of injury in the Level of Injury column.
2. The Physical Abilities column shows what muscle movement is common for anyone with a complete injury at that level.
3. The Functional Goals column outlines how people might manage typical daily activities based at that level of injury.
4. The Equipment Used column suggests various equipment options that might be useful in accomplishing those functional goals.

Level of Injury	Physical Abilities	Functional Goals	Equipment Used
C1–C3	C3—Limited movement of head and neck.	<b>Breathing:</b> Depends on ventilator for breathing.	Suction equipment to clear secretions, two ventilators with backup generator and battery
		<b>Communication:</b> Talking is sometimes difficult, very limited, or impossible. If the ability to talk is limited, communication can be accomplished independently, with adaptive equipment.	Mouth stick and assistive technology (e.g., computer, communication board) for speech or typing
		<b>Daily tasks:</b> Full assistance from caregiver for turning in bed, transfers, and all self-care (including bowel and bladder management). Assistive technology can allow for independence in such tasks as reading a book or newspaper, using a telephone, and operating lights and appliances.	Mouth stick, environmental control unit (ECU)
		<b>Mobility:</b> Can operate an electric wheelchair by using a head control, mouth stick, sip and puff, or chin control. Can also operate a power tilt wheelchair also for independent pressure relief.	Power or manual lift, electric or semi-electric hospital bed, power wheelchair with pressure-relieving cushion
C3–C4	Usually has head and neck control. At C4 level, may shrug shoulders.	<b>Breathing:</b> May initially require a ventilator for breathing; usually adjusts to breathing full time without ventilator assistance.	Cough-assist device
		<b>Communication:</b> Normal.	
		<b>Daily Tasks:</b> Individual requires full assistance from a caregiver for turning in bed, transfers, and all self-care (including bowel and bladder management). Individual may be able to use adaptive equipment to eat independently. May also be able to operate an adjustable bed and perform other tasks, such as painting, writing, typing, and using a telephone with assistive technology.	<b>Eating:</b> Sandwich holder on a gooseneck, feeder, long straw for liquids <b>Other Activities:</b> ECU for operating bed (e.g., head or voice activated, mouth stick controller), hands-free devices, mouth stick for typing, etc.
		<b>Mobility:</b> Can operate a power wheelchair by using head control, a mouth stick, sip and puff, or chin control. Power tilt function on wheelchair allows for independence with pressure relief.	Power or manual lift, electric or semi-electric hospital bed, power wheelchair with pressure-relieving cushion

Level of Injury	Physical Abilities	Functional Goals	Equipment Used
C5	Typically has head and neck control, can shrug shoulders, and has some shoulder control. Can bend elbows and turn palms face up.	<b>Daily Tasks:</b> Individual can be independent with eating and grooming (e.g., face washing, oral care, shaving, make-up application) after setup from caregiver, with specialized equipment. Individuals will require total assistance from caregiver for bed mobility, transfers, and all other self-care. May be able to assist caregiver with upper body dressing and some bathing, with adaptive equipment.	<b>Eating:</b> Universal cuff for attachment of utensils, scoop plate, plate guard, long straw <b>Grooming:</b> Universal cuff for attachment of tooth brush, comb or brush, adapted or electric razor, makeup applicators; wash mitt for face <b>Bathing:</b> Roll-in padded shower and commode chair, or padded transfer tub bench; wash mitt, adapted loofah
		<b>Health Care:</b> Individual will require assistance from caregiver for cough assist. Can perform pressure relief with power tilt in power wheelchair.	Cough-assist device
		<b>Mobility:</b> May have strength to push a manual wheelchair for short distances over level surfaces; however, a power wheelchair with hand controls will be required for daily activities. At this level, the individual may be able to drive with specialized hand controls in a modified van with a lift, but still may require attendant to assist with transportation.	<b>Wheelchair:</b> Power or manual lift, electric or semi-electric hospital bed, power wheelchair with pressure-relieving cushion <b>Bed:</b> Bed ladder, thigh straps, and bed rails used for bed mobility
		<b>Bowel and Bladder Management:</b> Individual requires total assistance from caregiver for bowel and bladder management. Individual may have indwelling catheter or the caregiver may perform intermittent catheterization for bladder management. Bowel management can be performed with use of specialized equipment or medication.	<b>Bowel:</b> Roll-in padded shower and commode chair, or padded transfer tub bench <b>Bladder:</b> Leg-bag emptier
C6	Has movement in head, neck, shoulders, arms, and wrists. Can shrug shoulders, bend elbows, turn palms up and down, and extend wrists.	<b>Daily Tasks:</b> With use of some specialized equipment and setup from a caregiver, an individual can be independent with most feeding, grooming, and upper body dressing. Will still require some assistance for lower body dressing and will be able to assist with upper body during bathing. Can perform sliding board transfers to padded shower commode chair and/or tub bench for toileting and bathing, with some to total assist from caregiver. Can perform some light meal preparation tasks.	<b>Feeding:</b> Universal cuff, built-up utensils, scoop plate, long straw, plate guard <b>Grooming:</b> Universal cuff, adapted electric razor, or toothbrush <b>Dressing:</b> Dressing stick, leg lifter, thigh straps, dressing hook splints; adapted or specialized clothing <b>Bathing:</b> Adapted loofah, long-handled sponge with universal cuff <b>Transfers:</b> Power or manual lift, sliding board, padded drop-arm bedside commode, padded tub bench with cutout, padded shower and commode chair
		<b>Health Care:</b> Can independently perform pressure relief with power tilt and may require some to no assist for forward or lateral lean pressure relief.	

Level of Injury	Physical Abilities	Functional Goals	Equipment Used
		<p><b>Mobility:</b> An individual may require some to no assist for turning in bed, with use of special equipment. May be able to perform sliding board transfers on level surfaces with some to no assistance from caregiver. Can use a ultra-lightweight manual wheelchair for mobility, but some may use a power wheelchair for greater ease over uneven terrain. Can be independent driving a vehicle from power or manual wheelchair with specialized equipment.</p>	<p><b>Bed:</b> Bed ladder, thigh straps, bed rails</p> <p><b>Wheelchair:</b> Wheelchair pegs, specialized wheelchair gloves, and rubber tubing on wheels. Also, power-assist wheels can be used for independence with manual wheelchair propulsion.</p> <p><b>Transportation:</b> Modified van with lift, specialized hand controls, tie-downs</p>
		<p><b>Bowel and Bladder Management:</b> Some to total assist with adaptive equipment for management of bowel and bladder.</p>	<p><b>Bowel:</b> Digital stimulation splint device, enema insertion device</p> <p><b>Bladder:</b> Catheter inserter, penis positioner, thigh spreader with mirror</p>
C7–T1	<p>Has movement similar to C6 level, with the added ability to straighten elbows.</p> <p>At the C8–T1 level, has added strength and precision of hands and fingers.</p>	<p><b>Daily Tasks:</b> Independent with all feeding, grooming, and upper body dressing, with equipment. Individuals may require some to no assistance with lower body dressing and bathing with equipment. Can perform sliding board transfers with some to no assistance to padded shower commode chair and/or tub bench for toileting and bathing.</p>	<p><b>Feeding:</b> Universal cuff, built-up handles, curved utensils, long straw, plate guard, adapted techniques for grasp</p> <p><b>Grooming:</b> Universal cuff, splint material to adapt devices</p> <p><b>Dressing:</b> Leg lifter, dressing stick, zipper pull, hooks on shoes</p> <p><b>Bathing:</b> Adapted loofah, long-handled sponge with universal cuff</p> <p><b>Transfers:</b> Sliding board, padded drop-arm bedside commode, padded tub bench with cutout, padded shower and commode chair</p>
		<p><b>Health Care:</b> Independent with wheelchair pushup or lateral lean for pressure relief.</p>	
		<p><b>Mobility:</b> Independent with manual wheelchair propulsion and level surface sliding board transfers. Some assistance may be required from caregiver for uphill transfers. Can be independent with driving if able to load and unload wheelchair.</p>	<p><b>Wheelchair:</b> Rigid or folding lightweight wheelchair, wheelchair pegs, wheelchair gloves</p> <p><b>Transportation:</b> Hand controls, modified van if unable to perform transfer or load–unload chair</p>
		<p><b>Bowel and Bladder Management:</b> Depending on hand function, some to total assist for bowel management, with use of adaptive equipment or medication. Can be independent or need some assist for bladder management with ICP or condom catheter.</p>	<p><b>Bowel:</b> Digital stimulation splint device, enema insertion device, toileting aid</p> <p><b>Bladder:</b> Catheter inserter house hold (for men), thigh spreader with mirror (for women)</p>
T2–T12	<p>Has normal motor function in head, neck, shoulders, arms, hands, and fingers. Has increased use of rib and chest muscles, or trunk control. At the T10–T12 level, more improvements in trunk control due to increase in abdominal strength.</p>	<p><b>Daily Tasks:</b> Independent with all self-care, including bowel and bladder management, with adaptive equipment if necessary.</p>	<p><b>Dressing:</b> Thigh straps, reacher, dressing stick, sock aid</p> <p><b>Bathing:</b> Long-handled sponge</p> <p><b>Transfers:</b> Sliding board, padded drop-arm bedside commode, padded tub bench with cutout, padded shower/commode chair</p> <p><b>Bowel/Bladder:</b> Mirror</p>
		<p><b>Health Care:</b> Independent with wheelchair pushup for pressure relief.</p>	

Level of Injury	Physical Abilities	Functional Goals	Equipment Used
		<b>Mobility:</b> Independent with all bed mobility and transfers, with or without use of equipment. Independent with wheelchair propulsion on uneven and even surfaces and up and down curbs. Able to load and unload wheelchair independently for driving with hand controls.	<b>Wheelchair:</b> Ultra-lightweight wheelchair <b>Transfers:</b> Sliding board, leg straps <b>Transportation:</b> Hand controls
L1–L5	Has additional return of motor movement in the hips and knees.	<b>Mobility:</b> Independent with all bed mobility and transfers with or without use of equipment. Independent with wheelchair propulsion on uneven and even surfaces and up and down curbs. Ambulation possible with use of specialized leg braces and walking devices. Functionality of ambulation depends on strength and movement in legs. Individuals' ability to ambulate depends primarily on their level household distances. Individuals may use a wheelchair for community mobility. Able to load and unload wheelchair independently for driving with hand controls.	<b>Wheelchair:</b> Ultra-lightweight wheelchair if necessary. <b>Walking:</b> Leg braces that extend to the hip, the knee, or just the ankle/foot and varying assistive devices <b>Transportation:</b> Hand controls
S1–S5	Depending on level of injury, various degrees of return of voluntary bladder, bowel, and sexual function.	<b>Mobility:</b> Increased ability to walk with fewer to no bracing or assistive devices.	<b>Walking:</b> Braces that support the ankle/foot

## Authorship

“*Understanding Spinal Cord Injury: Part 2—Recovery and Rehabilitation*” was developed by Phil Klebine, M.A.; Olivia Smitherman, M.O.T.R./L.; and Laney Gernenz, P.T. in collaboration with the Model Systems Knowledge Translation Center.

**Source:** Portions of this document were adapted from materials developed by the UAB SCI Model System, Northwest Regional SCI System, Southeastern Regional Spinal Cord Injury Care System, Rocky Mountain Regional Spinal Injury System, and Paralyzed Veterans of America Consortium for Spinal Cord Medicine.

**Disclaimer:** This information is not meant to replace the advice of a medical professional. You should consult your health care provider regarding specific medical concerns or treatment. The contents of this fact sheet were developed under a grant from the Department of Education, NIDRR grant number H133A110004. However, those contents do not necessarily represent the policy of the Department of Education, and you should not assume endorsement by the federal government.

**Copyright** © 2015 Model Systems Knowledge Translation Center (MSKTC). May be reproduced and distributed freely with appropriate attribution. Prior permission must be obtained for inclusion in fee-based materials.

**More in the “Understanding Spinal Cord Injury” series:** Part 1: The Body Before and After Spinal Cord Injury



If you have a spinal cord injury (SCI), you have a higher risk for urinary tract infection (UTI). UTI is one of the most common medical problems after SCI. This fact sheet explains your risk for UTI, how to best prevent it, and what to do if you get it.

## What is a urinary tract infection?

A urinary tract infection (UTI) is an infection in your urinary system. This system includes your kidneys, ureters, bladder, and urethra.

## What causes UTI?

The most common cause of UTI starts when bacteria enter the bladder through the urethra. The bacteria may multiply in the bladder to become UTI.

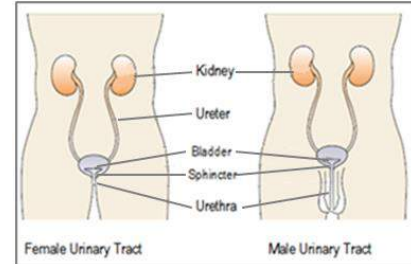

## What are bacteria?

Bacteria are tiny, living organisms. Good bacteria in your body help you to digest food and protect you from bad bacteria. Bad bacteria cause infections and make you sick.

## Is UTI common after spinal cord injury (SCI)?

Yes. Here are 3 of the more common reasons people with SCI develop UTIs.

1. Most people lose normal urinary function after SCI. They need a bladder management option to empty the urine from their bladder to keep their bladder and kidneys healthy. Most bladder management options make it easier for bacteria to enter the bladder through the urethra.
  - Please read "[Bladder Management Options Following Spinal Cord Injury](#)" to learn more about normal urinary function, how it changes after SCI, and bladder management options.
2. Most people lose normal bowel function after SCI, and contact with stool is common during bowel management. Stool has bacteria that can cause a UTI. UTIs are often caused when bacteria from stool gets into the bladder when the bladder is being emptied.
  - Please read "[Bowel Function after Spinal Cord Injury](#)" to learn more about normal bowel function, how it changes after SCI, and bowel management options.
3. Once in the bladder, bacteria are hard to get rid of. People with normal bladder function can usually get rid of most bacteria by fully emptying their bladder when they urinate. However, many people with SCI can't fully empty their bladder, even with good bladder management. This allows bacteria to stay in the bladder almost all of the time, making it easier for a UTI to develop.

## What is my risk for UTI?

Anyone can get UTI. However, people with SCI have a higher risk than normal.

- People with SCI who use an indwelling Foley or suprapubic catheter may be at higher risk for UTI than those who use a clean intermittent catheterization technique or have an external sheath or condom catheter.
  - Talk to your health professional about lowering your risk for UTI if you average more than one UTI per year. Your health professional may suggest another method of bladder management that works better for you.
- Women may be at a higher risk for UTI than men because a woman's urethra (see diagram above) is shorter and located closer to the anus. This can make it easier for bacteria from the colon to enter the bladder through the urethra.

The contents of this fact sheet are based on research evidence and/or professional consensus and has been reviewed and approved by an editorial team of experts from the Spinal Cord Injury Model Systems, which is sponsored by the National Institute on Disability, Independent Living, and Rehabilitation Research (See [www.msctc.org/sci/model-system-centers](http://www.msctc.org/sci/model-system-centers) for more information).

## Can I prevent UTIs?

Most people with SCI get UTIs. Even if you can't avoid UTIs, you can do a few basic practices to reduce your chances of getting them.

### Prevent your bladder from getting too full

Empty your bladder when needed. Empty it completely each time. This will help to reduce your chances of developing two common problems that increase your risk for UTI.

1. Over-distended bladder—Your bladder becomes over-stretched when it holds too much urine. This damages the bladder wall and forces the urine back into the ureters and kidneys.
2. Bladder or kidney stones—Excess sediment and calcium in urine can form into stones that can restrict the flow of urine.

### Get plenty of water

Your body needs the proper amount of water to stay hydrated and healthy. Here are a few of the vital health benefits from staying hydrated:

- Helps to flush out bacteria from the bladder
- Helps to maintain body temperature
- Helps to ease the flow of stool through the bowel
- Helps to keep the skin moist, supple, and healthy

Your body absorbs a small amount of water from the foods you eat. But what you drink is your body's main source of water. This is why you need to drink plenty of water. The color of your urine can help guide you in getting enough water. Ideally, your urine should be golden yellow. You probably need to drink more water if your urine is darker. Here is a color guide to help you. →



- Your diet and certain medications, including dietary supplements, can affect the color of your urine. For example, blackberries, beets, and rhubarb can turn urine darker. Vitamin B can turn urine bright yellow.
- Talk to your health professional before you change the amount of water you drink. You may need to adjust your bladder management. For example, you may need to empty your bladder more often if you increase the amount of water you drink.

### Eat healthy and exercise

A healthy diet and exercise are two of the best ways for most everyone with SCI to boost their immune system. A healthy immune system helps you to fight off infections.

- Ask your health professional for advice before starting an exercise program or changing your diet.
- Consider taking vitamin and mineral supplements. Zinc; magnesium; and vitamins A, B6, B12, C, D, and E may help to boost your immune system. Ask your health professional for advice before taking any supplements.

### Proper Hygiene

Staying clean is a good way to prevent the spread of bacteria. Always wash and clean properly both before and after bladder and bowel management and after accidents.

### Take a cranberry pill

Many people insist that cranberries help to prevent UTIs. But research is mixed on the benefits of cranberries. If you think it helps, take a daily cranberry pill instead of drinking the juice. This way you get the benefits of cranberries without the added sugar that is found in most juices.

### Watch for early signs of infection

You may notice warning signs before you start to experience symptoms of UTI.

- Gritty sediment in the urine.
- Mucus in the urine. This is often a sign of high levels of bacteria in the urine.
- Dark, cloudy or bad smelling urine.

If you notice any of these, you might be able to fend off UTI.

- Cut back on drinking liquids with alcohol, caffeine, and sugar.
- Drink more water to help wash out more of the bacteria
- If you do intermittent catheterization, do it more often. If you use an indwelling catheter, change it. Consider changing it again after the early signs of infection have gone away.



## Should I take antibiotics to prevent UTI?

Not usually. Antibiotics are medicines used to kill bacteria that cause infection. When you take an antibiotic to kill bacteria, the bacteria can change or adapt in a way that it becomes “resistant” to the antibiotic being used. This means that the antibiotic can no longer kill the bacteria. It takes a stronger antibiotic to then kill the bacteria in the future. There are a limited number of antibiotics that can kill bacteria, so it’s best to use antibiotics only when needed to avoid reaching the point when the bacteria are resistant to all antibiotics.

Here are a few recommendations for using antibiotics and better avoiding antibiotic resistance.

- Do not take antibiotics that are not prescribed to you.
- Do not take antibiotics for conditions that do not require them. For example, don’t take antibiotics to treat viruses like the cold or flu.
- Do not take antibiotics simply because your urine has bacteria. It is very common for people with SCI to have bacteria in their urine, so you usually only need to take an antibiotic to treat a UTI when you begin to you have signs and symptoms.
  - Antibiotics may be used to prevent infection in some situations. For example, women with SCI are often prescribed antibiotics to prevent UTI during pregnancy.

## What are the signs and symptoms of UTI?

You may have UTI if you start having one or more of these signs or symptoms.

- Fever (usually at least 100°F or 38°C)
- Chills
- Nausea
- Headache
- Urine with mucus and/or sediment
- Feeling tired or sluggish
- Changes in muscle spasms
- Dark or cloudy urine and/or urine that smells bad
- Lower back pain, if you have sensation in that area
- Autonomic dysreflexia, if your injury is T6 or above

## What should I do if I have signs and symptoms of UTI?

- Contact your health professional right away for advice on treatment.
- Always provide your health professional with a urine sample for testing. The test results are needed to prescribe the most effective antibiotic to treat the specific bacteria that is causing the UTI. The test also helps to make sure that the infection is not being caused by other health problems.
  - Collect the urine sample in a sterile cup using a sterile catheter. Do not collect the urine from a leg bag or night bag.
  - After you’ve collected your urine sample, give it directly to your health professional within 2 hours of being collected. If there is a delay, keep the sample cool or refrigerated.
- Take the antibiotic exactly as prescribed and over the prescribed time frame. Do not stop taking it when you begin to feel better.
- Drink plenty of water to wash out more of the bacteria. Stop drinking liquids with alcohol, caffeine, and sugar.
  - Ask your health professional if intermittent catheterization should be done more often than normal.
- Contact your health professional if you continue to have signs or symptoms of infection after you finish taking the antibiotic.

## Authorship

*Urinary Tract Infection and Spinal Cord Injury* was developed by Phil Klebine, M.A., and Keneshia Kirksey, M.D., in collaboration with the Model Systems Knowledge Translation Center.

**Source:** Portions of this document were adapted from materials developed by the UAB SCI Model System and Rocky Mountain Regional Spinal Injury System.

**Disclaimer:** This information is not meant to replace the advice of a medical professional. You should consult your health care provider regarding specific medical concerns or treatment. The contents of this fact sheet were developed under a grant (number 90DP0012) from the National Institute on Disability, Independent Living, and Rehabilitation Research (NIDILRR). NIDILRR is a Center within the Administration for Community Living (ACL), U.S. Department of Health and Human Services (HHS). The contents of this fact sheet do not necessarily represent the policy of NIDILRR, ACL, and HHS, and you should not assume endorsement by the federal government.

**Copyright** © 2017 Model Systems Knowledge Translation Center (MSKTC). May be reproduced and distributed freely with appropriate attribution.







